

## PATIENT MEDICATION INFORMATION

### READ THIS FOR SAFE AND EFFECTIVE USE OF YOUR MEDICINE

Pr**Alhemo**<sup>™</sup>

#### concizumab injection

Read this carefully before you start taking **Alhemo** and each time you get a refill. This leaflet is a summary and will not tell you everything about this drug. Talk to your healthcare professional about your medical condition and treatment and ask if there is any new information about **Alhemo**.

#### Serious Warnings and Precautions

Alhemo may cause the following serious side effects:

- **Blood Clots.** Blood clots (thromboembolic events) have occurred in patients treated with Alhemo.

Tell your healthcare provider if you or a family member have had blood clots in the past.

Stop taking Alhemo and tell your healthcare provider if you have any signs or symptoms of blood clots during treatment with Alhemo, including:

- swelling, pain, or tenderness in one or both legs and arms
- sudden, unexplained chest or upper back pain
- sudden, unexplained stomach or lower back pain
- shortness of breath or difficulty breathing

Discuss with your healthcare provider when you need other treatments to control bleeding while on Alhemo. These other medicines could increase your risks of developing clots and you may be told to take a dose lower than you would normally.

#### What is Alhemo used for?

Alhemo is a medicine used to treat people with hemophilia A or hemophilia B (bleeding conditions people are born with), which is caused by missing or faulty proteins (factor VIII or factor IX) that prevents blood from clotting normally. It is used for hemophilia A or hemophilia B patients who have developed “factor VIII inhibitors” or “factor IX inhibitors” that prevent replacement factor VIII or factor IX therapies from working properly.

#### How does Alhemo work?

Alhemo contains the active substance concizumab, which belongs to a group of medicines called ‘monoclonal antibodies’. The monoclonal antibody in Alhemo recognizes a protein (TFPI) that prevents clotting and by binding to this protein concizumab helps to increase clotting and stop bleeding in hemophilia patients.

#### What are the ingredients in Alhemo?

Medicinal ingredients: concizumab

Non-medicinal ingredients: L-Arginine HCl, L-Histidine, sodium chloride, sucrose, polysorbate 80, phenol, hydrochloric acid/sodium hydroxide (for pH adjustment) and water for injection.

**Alhemo comes in the following dosage forms:**

Alhemo is a clear to slightly yellow solution for injection in a pre-filled disposable pen containing Alhemo 15 mg (10 mg / mL), 60 mg (40 mg / mL), 150 mg (100 mg / mL), or 300 mg (100 mg / mL) of drug. Clear particles of protein are acceptable. Do not use if the solution is discoloured or contains solid foreign particles.

Each pack contains 1 pre-filled pen. Needles for injection are not included.

**Do not use Alhemo if:**

- You are allergic to the active substance or any of the other ingredients of this medicine. If you are not sure, talk to your doctor, pharmacist or nurse before using Alhemo.

**To help avoid side effects and ensure proper use, talk to your healthcare professional before you take Alhemo. Talk about any health conditions or problems you may have, including if you:**

Before you start using Alhemo, it is very important you talk to your doctor about when and how to use “bypassing agents” while receiving Alhemo, as this may differ from before. Your doctor will also tell you to stop take these medicines for up to 48 hours before your first dose of Alhemo.

Before you start using Alhemo tell your doctor if you have taken emicizumab to treat hemophilia A. You should stop taking emicizumab for at least 180 days before you are given Alhemo.

The following potential serious side effects may occur. Talk to your doctor if you have had allergic reactions in the past or have had a history or family history of developing clots.

***Allergic reactions (hypersensitivity reactions)***

Allergic reactions have occurred in patients treated with Alhemo. Stop the treatment and contact your healthcare provider in case you have signs or symptoms of an allergic reaction such as rash, redness, hives and itching. You could also experience more severe signs of allergic reactions (e.g., anaphylactic reaction) such as itching on large areas of skin, redness and/or swelling of lips, tongue, face or hands, difficulty in swallowing, shortness of breath, wheezing, tightness of the chest, pale and cold skin, fast heartbeat, or dizziness (low blood pressure), which will need immediate medical attention.

**If you have any signs of allergic reactions: stop taking Alhemo and seek emergency help right away*****Blood clots (thromboembolic events)***

Blood clots have occurred in patients treated Alhemo and these can form anywhere in the body including legs, chest, arms, head, and kidneys.

In case you experience signs or symptoms of blood clots you should stop taking Alhemo and contact your doctor immediately.

Signs and symptoms of blood clots may include:

- swelling, warmth, pain, or redness of the skin – this could be symptoms of a blood clot

- in your legs or arms.
- feeling short of breath, severe chest pain – this could be symptoms of blood clots in your chest (heart and lungs).
- headache, feeling confused, trouble with speech or movement, numbness in your face, eye pain or swelling or problems with your vision – this could be symptoms of a blood clot in your brain or eyes.
- sudden pain in your stomach or lumbar area – this could be symptoms of blood clots in your gut or kidneys.

**If you have any signs of blood clots: stop taking Alhemo and seek emergency help right away.**

Other warnings you should know about:

#### Children and Adolescents

Alhemo can be used in adolescents (aged 12 to 18 years of age). The dose in adolescents is also calculated according to body weight and is the same dose as for adults. If you are younger than 12 years of age you should not take Alhemo.

#### Pregnancy, breast-feeding and fertility

You should use a highly effective method of birth control (contraception) during treatment with Alhemo and for 7 weeks after your last injection of Alhemo. Talk to your doctor about the type of contraceptives to use.

If you are pregnant or breast-feeding, think you may be pregnant or are planning to have a baby, ask your doctor for advice before using this medicine or continuing on this medicine.

#### Immunogenicity

Your body may make proteins (antibodies) that may stop Alhemo from working properly. Contact your healthcare professional if you notice Alhemo has stopped working for you (e.g. increase in bleeds).

Tell your healthcare professional about all the medicines you take, including any drugs, vitamins, minerals, natural supplements or alternative medicines.

#### **How to take Alhemo:**

Stop taking other therapies to prevent bleeds before starting Alhemo.

See the detailed Instructions for Use before using your Alhemo pen. Always use this medicine Alhemo exactly as your healthcare provider has told you regarding dose and frequency. Check with your doctor, pharmacist, or nurse if you are not sure.

Alhemo is given by injection under the skin (subcutaneously). Your doctor or nurse will show you and/or your caregiver how to inject Alhemo. Once you and/or your caregiver have been trained, you should be able to inject this medicine at home, by yourself or with the help of a caregiver.

Your healthcare provider will show you and/or your caregiver which areas of the body should be injected with Alhemo. You should give Alhemo under the skin in the stomach, or the thighs.

Ask your doctor if you need to use alternative injection techniques, e.g. lean patients and

children may need to inject into a loosely held fold of skin to avoid injecting too deep (into the muscle).

Each time you or your caregiver gives an injection, use a different area of the body to the one you used before, using one of the recommended places (the stomach or the thighs).

Usual dose:

- Day 1: The dose is 1 milligram for every 1 kilogram you weigh.
- Day 2 and onwards, until your doctor prescribes you your individual maintenance dose: 0.2 milligrams for every 1 kilogram you weigh, injected once a day

Your doctor will measure the levels of concizumab in your blood 4 weeks after you have started treatment, and prescribe your individual maintenance dose as listed below:

- 0.25 milligrams for every 1 kilogram you weigh, injected once a day or,
- 0.20 milligrams for every 1 kilogram you weigh, injected once a day or,
- 0.15 milligrams for every 1 kilogram you weigh, injected once a day.

If you are told to take 0.15 milligrams for every 1 kilogram you weigh, you should have your levels of concizumab taken 8 weeks after you started on this dose to make sure it is safe for you to remain on therapy.

Additional tests to measure concizumab levels in your blood may be necessary. This may be required if you start bleeding more often than you have in the past.

Your dose is dialed at increments of

- 0.1 mg on the 10 mg / mL pen (blue dose button and cartridge holder),
- 0.4 mg on the 40 mg / mL pen (brown dose button and cartridge holder), and
- 1.0 mg on the 100 mg / mL pen (gold dose button and cartridge holder).

Your doctor or nurse will assist you in determining the correct injectable dose on the pen and if this dose needs to be changed. Your doctor should give you the pen that can deliver your daily dose in one injection.

#### Management of breakthrough bleeds

Before you start using Alhemo talk with your doctor. Your doctor will also tell you about how to handle a potential bleed.

- Talk with your doctor about how to handle a potential bleed while on this therapy.
- Alhemo makes the blood coagulation more effective. Therefore, to avoid dangerous blood clots, the dose of a bypassing agent may be lower than the dose you used prior to starting Alhemo.

#### **Overdose:**

- If you use more Alhemo than you should, contact your healthcare professional immediately.

If you think you, or a person you are caring for, have taken too much Alhemo, contact a healthcare professional, hospital emergency department, or regional poison control centre immediately, even if there are no symptoms.

**Missed Dose:**

One or more missed doses of Alhemo affects how well the drug works. It is important to take Alhemo every day. If you or your caregiver cannot take or give the drug every day, see if there is a different drug available to treat or prevent your bleeds. If you miss a dose or multiple doses in a row follow the guidelines below:

- One missed daily dose: No additional dose is required. Take your normal dose the next day and do not make up for your missed dose.
- 2 to 6 missed daily doses in a row: Contact your healthcare professional right away. While your normal dose can be resumed, they may instruct you take the daily dose twice, and then continue taking your normal dose the next day. Do not make up for any missed doses.
- Seven or more missed daily doses in a row: Contact your healthcare professional right away. They may advise you to start a new loading dose (1 mg for every kilogram) before you continue with your daily dose the next day. Do not make up for any missed doses.
- Major surgery: Your doctor will tell you to stop taking Alhemo 4 days before your surgery. After your surgery wait at least another 10 days on the advice of your doctor before starting Alhemo at your normal dose. Do not make up for any missed doses.

If you are in doubt about what to do when you miss one or more doses of Alhemo contact your healthcare professional.

If you stop using Alhemo, you may no longer be protected against bleeding. Do not stop using Alhemo without talking to your doctor.

**What are possible side effects from using Alhemo?**

These are not all the possible side effects you may have when taking Alhemo. If you experience any side effects not listed here, tell your healthcare professional.

Very common: may affect more than 1 in 10 people

- A reaction in the area where the injection is given (such as redness, bleeding, itching, hives, swelling, pain, numbness)
- Joint pain

Common: may affect up to 1 in 10 people

- Allergic reaction (hypersensitivity reaction)
- Headache
- Fever
- Infections
- Increase in level of blood clotting component (fibrin D dimer)
- Increase in level of blood clotting component (prothrombin fragment 1.2)

Uncommon: may affect up to 1 in 100

- Blood clots (thromboembolisms)
- Itchy skin (pruritus)

Serious side effects and what to do about them			
Symptom / effect	Talk to your healthcare professional		Stop taking drug and get immediate medical help
	Only if severe	In all cases	
<b>COMMON</b>			
<b>Allergic reaction (hypersensitivity reaction):</b> Difficulty in swallowing or breathing; shortness of breath or wheezing; chest tightness; redness and/or swelling of the lips, tongue, face or hands; rash, hives, swollen marks on the skin or itching; pale and cold skin, fast heartbeat, or dizziness (sign of low blood pressure)		✓	✓
<b>Uncommon</b>			
<b>Blood Clots (thromboembolisms)</b> Signs and symptoms of blood clots may include: <ul style="list-style-type: none"> <li>• swelling, warmth, pain, or redness of the skin – this could be symptoms of a blood clot in your legs or arms.</li> <li>• feeling short of breath, severe chest pain – this could be symptoms of blood clots in your chest (heart and lungs).</li> <li>• headache, feeling confused, trouble with speech or movement, numbness in your face, eye pain or swelling or problems with your vision – this could be symptoms of a blood clot in your brain or eyes.</li> <li>• sudden pain in your stomach or lumbar area – this could be symptoms of blood clots in your gut or kidneys.</li> </ul>		✓	✓

If you have a troublesome symptom or side effect that is not listed here or becomes bad enough to interfere with your daily activities, tell your healthcare professional.

#### Reporting Side Effects

You can report any suspected side effects associated with the use of health products to Health Canada by:

- Visiting the Web page on Adverse Reaction Reporting (<https://www.canada.ca/en/health-canada/services/drugs-health-products/medeffect-canada.html>) for information on how to report online, by mail or by fax; or
- Calling toll-free at 1-866-234-2345.

NOTE: Contact your healthcare professional if you need information about how to manage your side effects. The Canada Vigilance Program does not provide medical advice.

#### Storage:

Keep this medicine out of the sight and reach of children.

Do not use this medicine after the expiry date which is stated on the pen label and carton after 'EXP'. The expiry date refers to the last day of that month.

Always store the pen in the original carton to protect from light.

Do not use this medicine if you notice that the solution is discoloured or contains solid foreign particles.

Before use:

- Store unused Alhemo pens at 2-8°C in a refrigerator.
- Store your new, unused pen with the pen cap on.
- When stored in the refrigerator, do not store the pen directly next to the cooling element.
- Do not use Alhemo if it has been frozen or stored at temperatures above 30°C.

Pen in use:

- Store the Alhemo pen you are currently using without a needle attached, either in the refrigerator at 2-8°C or at room temperatures below 30°C for up to 28 days.
  - If stored in the refrigerator, do not store the pen directly next to the cooling element. Do not use Alhemo if it has been frozen.
  - If stored at room temperature, do not use the pen if it has been stored above 30°C. Do not store the pen in direct sunlight.
- Store your in-use Alhemo pen with the pen cap on.

Do not throw away any medicines via wastewater or household waste. Ask your pharmacist how to throw away medicines you no longer use. These measures will help protect the environment.

If you want more information about Alhemo:

- Talk to your healthcare professional
- Find the full product monograph that is prepared for healthcare professionals and includes this Patient Medication Information by visiting the Health Canada website: (<https://www.canada.ca/en/health-canada/services/drugs-health-products/drug-products/drug-product-database.html>); the manufacturer's website [[www.novonordisk.ca](http://www.novonordisk.ca)], or by calling 1-800-465-4334.

This leaflet was prepared by Novo Nordisk Canada Inc.

Last Revised 2023

Alhemo is a trademark of Novo Nordisk Health Care AG and used under license by Novo Nordisk Canada Inc.

NovoFine® 32G TIP ETW, NovoFine® Plus and Novo Nordisk are trademarks of Novo Nordisk A/S and is used under license by Novo Nordisk Canada Inc.

© 2023

Novo Nordisk Canada Inc.



## INSTRUCTIONS FOR USE

### PrAlhemo™ 15 mg / 1.5 ml (10 mg / ml) solution for injection in pre-filled pen concizumab injection

For subcutaneous administration only

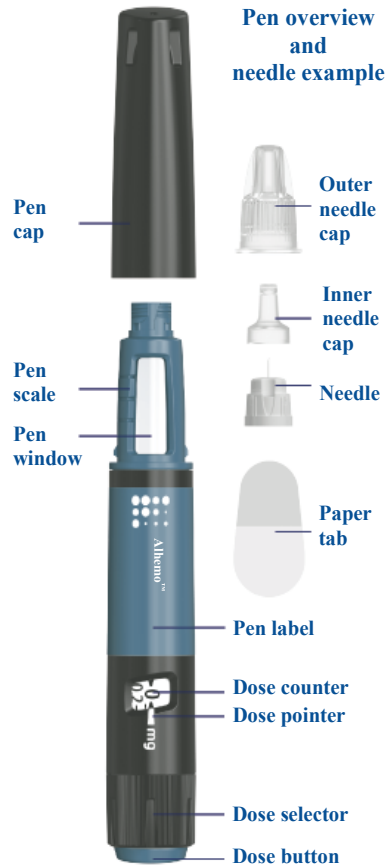

What is in this package?

- 1 Alhemo pen
- Package leaflet

Read the instructions and make sure you have received training from your doctor or nurse before you use the pen.

Follow the instructions from your doctor or nurse on how to use Alhemo and how often you should inject Alhemo.

The pen is pre-filled with 15 mg of Alhemo for subcutaneous administration only. The pen contains multiple doses of Alhemo.

The pen can deliver a maximum of 8 mg in one injection. The interval on the dose counter is

0.1 mg. If you need more than 8 mg, you need to inject multiple times. Other pens are available that can deliver your daily dose in one injection. Ask your doctor or nurse.

- Needles are not included. Use compatible injection needles of **4 mm in length**. This pen is designed to be used with NovoFine® 32G TIP ETW or NovoFine® Plus 32G x 4 mm injection needles.

### **Where on my body should I inject my dose?**

You can inject in the skin of:

- your stomach (abdomen) OR
- your thigh.

Inject in a 90° (ninety degree) angle. The grey areas on the picture to the right show the injection sites. For every injection, select a new injection site at least 5 centimetres away from where you last injected.

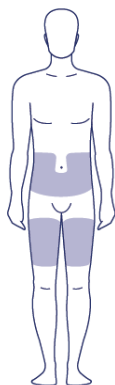

### **Check your pen**

1

#### **Check pen label**

Look at the name and colour to make sure you have the correct medication.

#### **Check expiration date**

Check the expiration date on the pen label to make sure it has not passed (EXP/MM/YYYY). If the expiration date has passed, do not use the pen.

#### **Inspect medication**

Pull off the pen cap and check that Alhemo in the pen window is almost clear and colourless to slightly yellow. Clear particles might be seen. If Alhemo looks discoloured, or if solid particles are seen, do not use the pen.

#### **If your pen is cold**

You can inject Alhemo right from the refrigerator or let it reach room temperature before you inject. You can warm the pen in the palms of your hands. Do not use any other heating sources.

## Attach a new needle

2

Take a new needle and tear off the paper tab.

- Push the needle straight onto your pen. Turn until it is on tight. See A.
- Pull off the outer needle cap and keep it. See B
- Pull off the inner needle cap and dispose of it. See B.

**Note:** Always use a new needle for each injection.

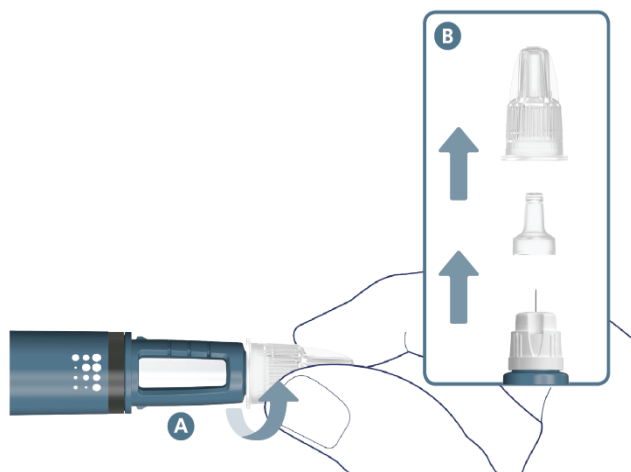

## Dial to '0.1' and test the flow

3

A drop of Alhemo may appear at the needle tip, but you should still test the Alhemo flow before **each injection** to avoid underdosing:

- a. Turn the dose selector one marking to select 0.1 mg. See A.
- b. Press the dose button. See B.
- c. Watch a stream of Alhemo leaving the needle tip. See B.

If no stream appears, go to Troubleshooting if no stream appears when testing the flow.

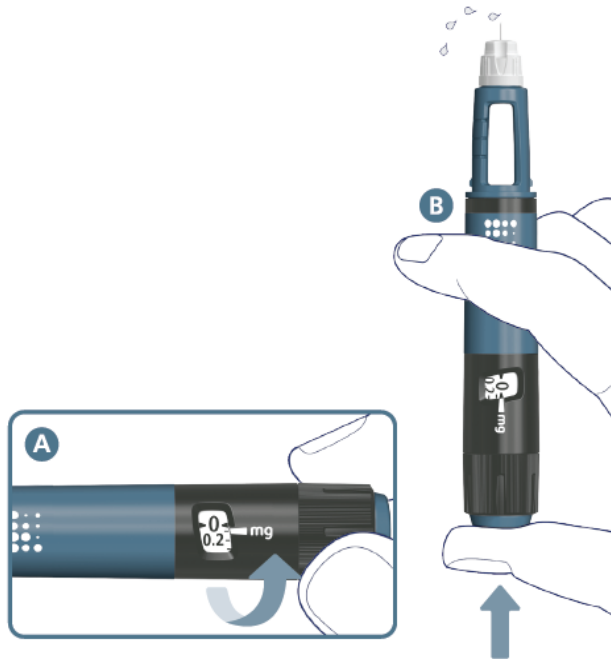

#### Select your dose

4

Turn the dose selector to select your prescribed dose.

You can adjust your dose by turning the dose selector in either direction.

If you need a larger dose than you can dial, you must inject yourself multiple times to get your full dose. Other pens are available that can deliver your daily dose in one injection. Ask your doctor or nurse. For more information, see step 6.

The pen contains 15 mg of Alhemo.

The pen can deliver a maximum of 8 mg in one injection.

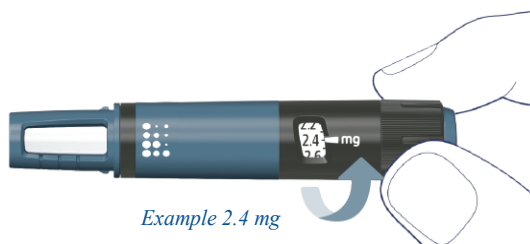

#### Inject your dose

5

Read through steps a. to e. before you start injecting.  
This is to make sure you get your full dose.

- a. Select the injection site. See Where on my body should I inject my dose?

- b. Insert the needle straight into your stomach (abdomen) or thigh in a 90° (ninety degree) angle.
- c. Press and hold the dose button down until the dose counter returns to <0>.
- d. While the needle is still in your skin, count slowly to 6, after the dose counter has returned to <0>.
- e. Retract the needle from your skin.

The pen clicks during dosing and you might also hear or feel a click when the dose counter returns to <0>.

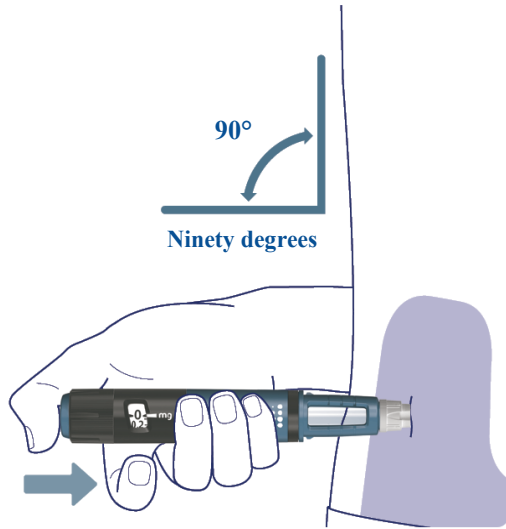

### Remove the needle 6

Remove the needle from your pen by leading the needle tip into the outer needle cap without touching the needle or the cap.

When the needle is covered, carefully push the outer needle cap completely on. Unscrew the needle. Do not touch the back end of the needle.

Dispose of the needle as instructed by your doctor, nurse, pharmacist or local authorities.

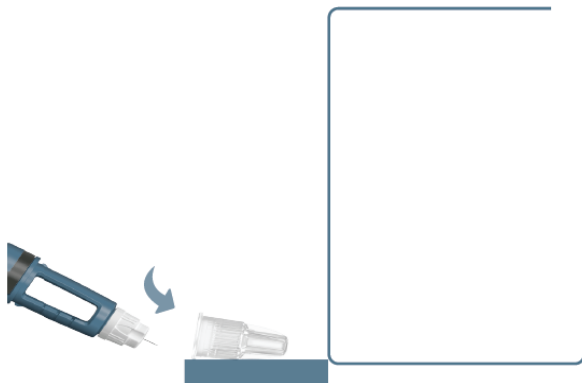

### Do you need a larger dose than you can dial?

Your doctor should give you a pen that can deliver your daily dose in one injection. If you need a larger dose than you can dial, you must inject yourself more than once to get your full dose. Repeat steps 1 to 6 until you have received your full dose. When you have received your full dose go to step 7.

- Use a new needle for each injection.
- Test the Alhemo flow before each injection.
- Accurately calculate how much to inject in each injection to receive your full dose.

### Completion 7

Put the pen cap back on your pen to protect Alhemo from light.

Now your pen is ready for storage until you need it next time.



#### Important information about your pen

- Make sure the pen contains the correct medication.
- Inspect the medication to ensure it is almost clear and colourless to slightly yellow and that no discoloration or solid particles are seen.
- Use a new needle for each injection.
- Pull off both the inner and the outer needle caps before injecting.
- Test the Alhemo flow before each injection.
- Confirm that you have selected the correct dose.
- Insert the needle in the skin of your stomach (abdomen) or thigh in a ninety degree (90°) angle.
- When injecting, make sure the dose counter returns to <0> and count slowly to 6 after it has returned to <0>.
- If you need a larger dose than you can dial, be accurate when calculating how much to take

in each injection.

- Remove the needle from your pen after injection.
- The pen is for single patient use only and must not be shared. Sharing may lead to infection and transmission of disease.
- Follow the instructions from your doctor or nurse on how to use Alhemo and how often you should inject Alhemo.
- After first use do not use your pen for more than 28 days.
- The pen can deliver doses from 0.1 mg to 8 mg in one injection.

### **Important information about needles**

Needles can be used for one injection only.

Do not re-use needles as this may lead to needle blockage, infection and incorrect dosing.

Never share needles with others.

Designed to be used with NovoFine® 32G TIP ETW or NovoFine® Plus 32G x 4 mm injection needles. If you use needles longer than 4 mm, talk to your doctor or nurse about how to perform your injection.

You can use the outer needle cap to remove the needle from your pen. Put the outer needle cap onto the needle and carefully remove the needle.

Never use a bent or damaged needle.

### **Troubleshooting if no stream appears when testing the flow (step 3)**

- If no stream appears, repeat step 3 up to six times until you see a stream.
- If still no stream appears, prepare a new needle (step 2) and test again (step 3).
- If still no stream appears after using a new needle, do not use the pen. Use a new pen.

### **How much Alhemo is left in your pen?**

The pen scale shows approximately how much Alhemo is left in your pen.

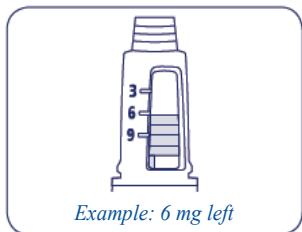

If you want to see more accurately how much Alhemo is left in your pen, turn the dose selector until it stops. The dose pointer will line up with the number of mg left in the pen. The number shown on the dose counter is the number of mg left in your pen.

If the dose counter shows 8, there is 8 mg or more is left in the pen. The example below shows 3.4 mg of Alhemo left in the pen.

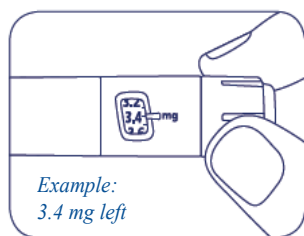

### **Storage**

See how to store your pen in the *Patient Medication Information* on the reverse side of this leaflet.

### **Take good care of your pen**

Do not expose your pen to dust, dirt or liquid.

Do not wash, soak or lubricate your pen. It may be cleaned with a mild detergent on a moistened cloth.

Keep your pen out of sight and reach of others, especially children.

### **Disposing of Alhemo pens, needles and packaging material**

When your pen is empty you must dispose of it according to your local regulations.

You cannot refill your pen.

To reduce the risk of a needle stick, dispose of used needles immediately as instructed by your doctor, nurse, pharmacist or local authorities.

The packaging material (the carton and leaflet) is recyclable.



## INSTRUCTIONS FOR USE

### PrAlhemo™ 60 mg / 1.5 ml (40 mg / ml) solution for injection in pre-filled pen concizumab injection

For subcutaneous administration only



### What is in this package?

- 1 Alhemo pen
- Package leaflet

Read the instructions and make sure you have received training from your doctor or nurse before you use the pen.

Follow the instructions from your doctor or nurse on how to use Alhemo and how often you should inject Alhemo.

The pen is pre-filled with 60 mg of Alhemo for subcutaneous administration only. The pen contains multiple doses of Alhemo.

The pen can deliver a maximum of 32 mg in one injection. The interval on the dose counter is

0.4 mg. If you need more than 32 mg, you need to inject multiple times. Other pens are available that can deliver your daily dose in one injection. Ask your doctor or nurse.

- Needles are not included. Use compatible injection needles of **4 mm in length**. This pen is designed to be used with NovoFine® 32G TIP ETW or NovoFine® Plus 32G x 4 mm injection needles.

### **Where on my body should I inject my dose?**

You can inject in the skin of:

- your stomach (abdomen) OR
- your thigh.

Inject in a 90° (ninety degree) angle. The grey areas on the picture to the right show the injection sites. For every injection, select a new injection site at least 5 centimetres away from where you last injected.

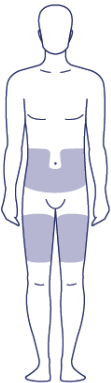

### **Check your pen 1**

#### **Check pen label**

Look at the name and colour to make sure you have the correct medication.

#### **Check expiration date**

Check the expiration date on the pen label to make sure it has not passed (EXP/MM/YYYY). If the expiration date has passed, do not use the pen.

#### **Inspect medication**

Pull off the pen cap and check that Alhemo in the pen window is almost clear and colourless to slightly yellow. Clear particles might be seen. If Alhemo looks discoloured, or if solid particles are seen, do not use the pen.

#### **If your pen is cold**

You can inject Alhemo right from the refrigerator or let it reach room temperature before you inject. You can warm the pen in the palms of your hands. Do not use any other heating sources.

## Attach a new needle

2

Take a new needle and tear off the paper tab.

- Push the needle straight onto your pen. Turn until it is on tight. See A.
- Pull off the outer needle cap and keep it. See B
- Pull off the inner needle cap and dispose of it. See B.

**Note:** Always use a new needle for each injection.

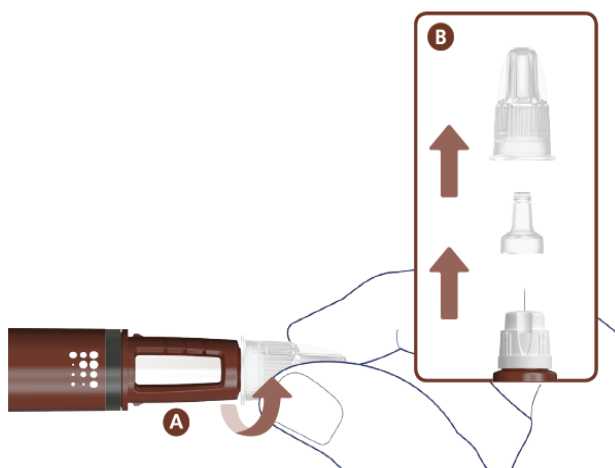

## Dial to '0.4' and test the flow

3

A drop of Alhemo may appear at the needle tip, but you should still test the Alhemo flow before **each injection** to avoid underdosing:

- Turn the dose selector one marking to select 0.4 mg. See A.
- Press the dose button. See B.
- Watch a stream of Alhemo leaving the needle tip. See B.

If no stream appears, go to Troubleshooting if no stream appears when testing the flow.

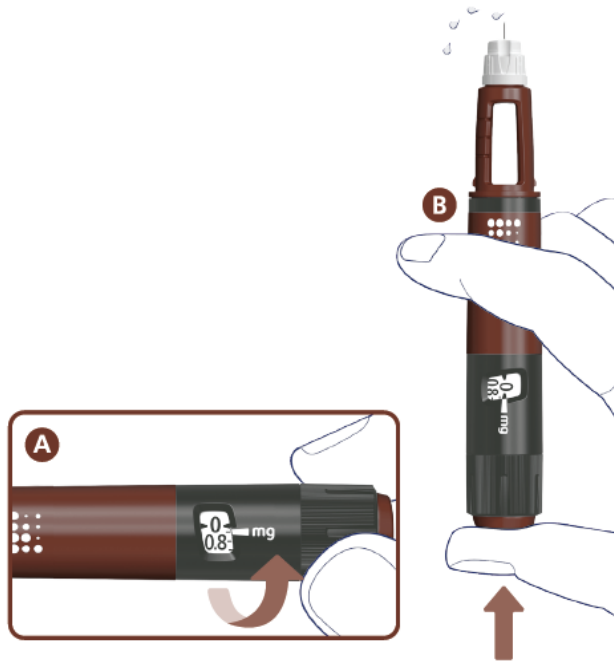

#### Select your dose

4

Turn the dose selector to select your prescribed dose.

You can adjust your dose by turning the dose selector in either direction.

If you need a larger dose than you can dial, you must inject yourself multiple times to get your full dose. Other pens are available that can deliver your daily dose in one injection. Ask your doctor or nurse. For more information, see step 6.

The pen contains 60 mg of Alhemo.

The pen can deliver a maximum of 32 mg in one injection.

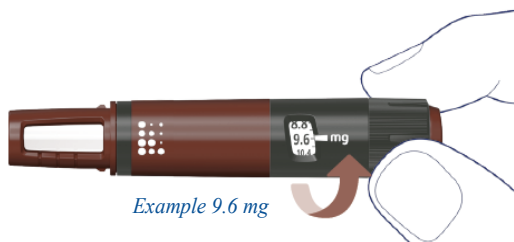

#### Inject your dose

5

Read through steps a. to e. before you start injecting.  
This is to make sure you get your full dose.

- f. Select the injection site. See Where on my body should I inject my dose?

- g. Insert the needle straight into your stomach (abdomen) or thigh in a 90° (ninety degree) angle.
- h. Press and hold the dose button down until the dose counter returns to <0>.
- i. While the needle is still in your skin, count slowly to 6, after the dose counter has returned to <0>.
- j. Retract the needle from your skin.

The pen clicks during dosing and you might also hear or feel a click when the dose counter returns to <0>.

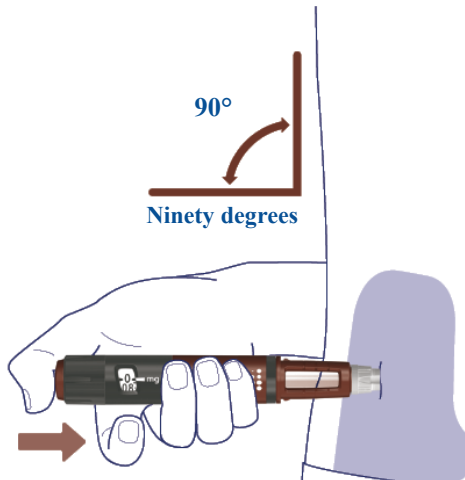

**Remove the needle 6**

Remove the needle from your pen by leading the needle tip into the outer needle cap without touching the needle or the cap.

When the needle is covered, carefully push the outer needle cap completely on. Unscrew the needle. Do not touch the back end of the needle.

Dispose of the needle as instructed by your doctor, nurse, pharmacist or local authorities.

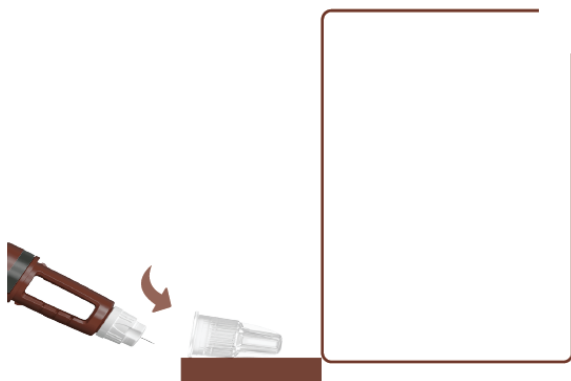

**Do you need a larger dose than you can dial?**

Your doctor should give you a pen that can deliver your daily dose in one injection. If you need a larger dose than you can dial, you must inject yourself more than once to get your full dose. Repeat steps 1 to 6 until you have received your full dose. When you have received your full dose go to step 7.

- Use a new needle for each injection.
- Test the Alhemo flow before each injection.
- Accurately calculate how much to inject in each injection to receive your full dose.

## Completion 7

Put the pen cap back on your pen to protect Alhemo from light.

Now your pen is ready for storage until you need it next time.



### Important information about your pen

- Make sure the pen contains the correct medication.
- Inspect the medication to ensure it is almost clear and colourless to slightly yellow and that no discoloration or solid particles are seen.
- Use a new needle for each injection.
- Pull off both the inner and the outer needle caps before injecting.
- Test the Alhemo flow before each injection.
- Confirm that you have selected the correct dose.
- Insert the needle in the skin of your stomach (abdomen) or thigh in a 90° (ninety degree) angle.
- When injecting, make sure the dose counter returns to <0> and count slowly to 6 after it has returned to <0>.
- If you need a larger dose than you can dial, be accurate when calculating how much to take in each injection.

- Remove the needle from your pen after injection.
- The pen is for single patient use only and must not be shared. Sharing may lead to infection and transmission of disease.
- Follow the instructions from your doctor or nurse on how to use Alhemo and how often you should inject Alhemo.
- After first use do not use your pen for more than 28 days.
- The pen can deliver doses from 0.4 mg to 32 mg in one injection.

### Important information about needles

Needles can be used for one injection only.

Do not re-use needles as this may lead to needle blockage, infection and incorrect dosing.

Never share needles with others.

Designed to be used with NovoFine® 32G TIP ETW or NovoFine® Plus 32G x 4 mm injection needles. If you use needles longer than 4 mm, talk to your doctor or nurse about how to perform your injection.

You can use the outer needle cap to remove the needle from your pen. Put the outer needle cap onto the needle and carefully remove the needle.

Never use a bent or damaged needle.

### Troubleshooting if no stream appears when testing the flow (step 3)

- If no stream appears, repeat step 3 up to six times until you see a stream.
- If still no stream appears, prepare a new needle (step 2) and test again (step 3).
- If still no stream appears after using a new needle, do not use the pen. Use a new pen.

### How much Alhemo is left in your pen?

The pen scale shows approximately how much Alhemo is left in your pen.

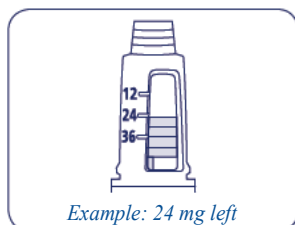

If you want to see more accurately how much Alhemo is left in your pen, turn the dose selector until it stops. The dose pointer will line up with the number of mg left in the pen. The number shown on the dose counter is the number of mg left in your pen.

If the dose counter shows 32, there is 32 mg or more is left in the pen. The example below shows 13.6 mg of Alhemo left in the pen.

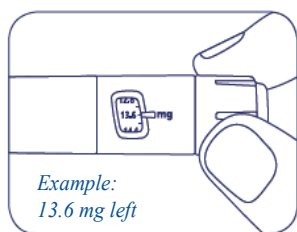

### **Storage**

See how to store your pen in the *Patient Medication Information* on the reverse side of this leaflet.

### **Take good care of your pen**

Do not expose your pen to dust, dirt or liquid.

Do not wash, soak or lubricate your pen. It may be cleaned with a mild detergent on a moistened cloth.

Keep your pen out of sight and reach of others, especially children.

### **Disposing of Alhemo pens, needles and packaging material**

When your pen is empty you must dispose of it according to your local regulations.

You cannot refill your pen.

To reduce the risk of a needle stick, dispose of used needles immediately as instructed by your doctor, nurse, pharmacist or local authorities.

The packaging material (the carton and leaflet) is recyclable.



## INSTRUCTIONS FOR USE

### PrAlhemo™ 150 mg / 1.5 ml (100 mg / ml) solution for injection in pre-filled pen concizumab injection

For subcutaneous administration only

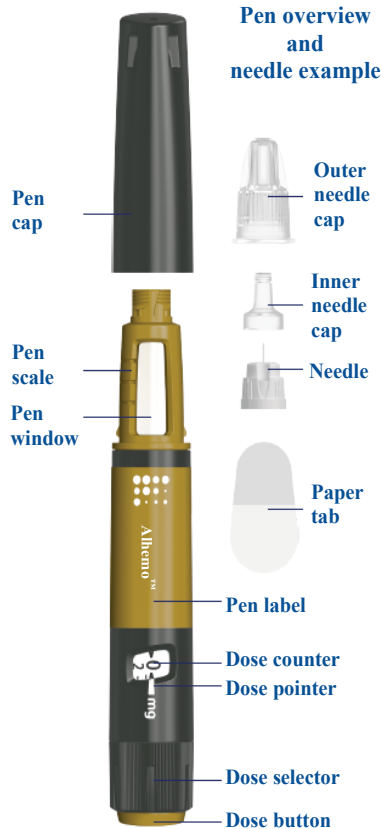

### What is in this package?

- 1 Alhemo pen
- Package leaflet

Read the instructions and make sure you have received training from your doctor or nurse before you use the pen.

Follow the instructions from your doctor or nurse on how to use Alhemo and how often you should inject Alhemo.

The pen is pre-filled with 150 mg of Alhemo for subcutaneous administration only. The pen contains multiple doses of Alhemo.

The pen can deliver a maximum of 80 mg in one injection. The interval on the dose counter is 1 mg. If you need more than 80 mg, you need to inject multiple times.

- Needles are not included. Use compatible injection needles of **4 mm in length**. This pen is designed to be used with NovoFine® 32G TIP ETW or NovoFine® Plus 32G x 4 mm injection needles.

### **Where on my body should I inject my dose?**

You can inject in the skin of:

- your stomach (abdomen) OR
- your thigh.

Inject in a 90° (ninety degree) angle. The grey areas on the picture to the right show the injection sites. For every injection, select a new injection site at least 5 centimetres away from where you last injected.

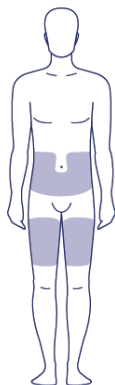

### **Check your pen** **1**

#### **Check pen label**

Look at the name and colour to make sure you have the correct medication.

#### **Check expiration date**

Check the expiration date on the pen label to make sure it has not passed (EXP/MM/YYYY). If the expiration date has passed, do not use the pen.

#### **Inspect medication**

Pull off the pen cap and check that Alhemo in the pen window is almost clear and colourless to slightly yellow. Clear particles might be seen. If Alhemo looks discoloured, or if solid particles are seen, do not use the pen.

#### **If your pen is cold**

You can inject Alhemo right from the refrigerator or let it reach room temperature before you inject. You can warm the pen in the palms of your hands. Do not use any other heating sources.

### **Attach a new needle** **2**

Take a new needle and tear off the paper tab.

- Push the needle straight onto your pen. Turn until it is on tight. See A.
- Pull off the outer needle cap and keep it. See B
- Pull off the inner needle cap and dispose of it. See B.

**Note:** Always use a new needle for each injection.

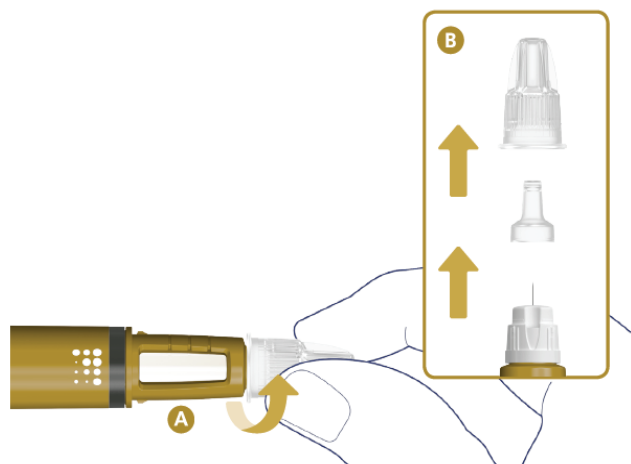

### Dial to '1' and test the flow

3

A drop of Alhemo may appear at the needle tip, but you should still test the Alhemo flow before **each injection** to avoid underdosing:

- g. Turn the dose selector one marking to select 1 mg. See A.
- h. Press the dose button. See B.
- i. Watch a stream of Alhemo leaving the needle tip. See B.

If no stream appears, go to Troubleshooting if no stream appears when testing the flow.

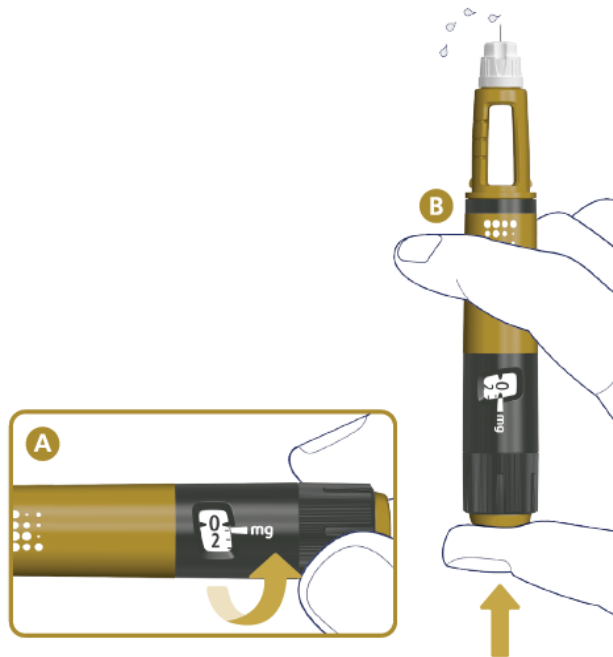

#### Select your dose

4

Turn the dose selector to select your prescribed dose.

You can adjust your dose by turning the dose selector in either direction.

If you need a larger dose than you can dial, you must inject yourself multiple times to get your full dose. For more information, see step 6.

The pen contains 150 mg of Alhemo.

The pen can deliver a maximum of 80 mg in one injection.

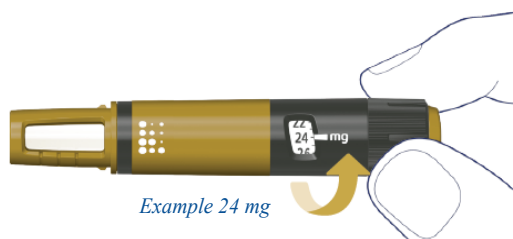

#### Inject your dose

5

Read through steps a. to e. before you start injecting.  
This is to make sure you get your full dose.

- k. Select the injection site. See *Where on my body should I inject my dose?*
- l. Insert the needle straight into your stomach (abdomen) or thigh in a 90° (ninety

- degree) angle.
- m. Press and hold the dose button down until the dose counter returns to **<0>**.
  - n. While the needle is still in your skin, count slowly to 6, after the dose counter has returned to **<0>**.
  - o. Retract the needle from your skin.

The pen clicks during dosing and you might also hear or feel a click when the dose counter returns to **<0>**.

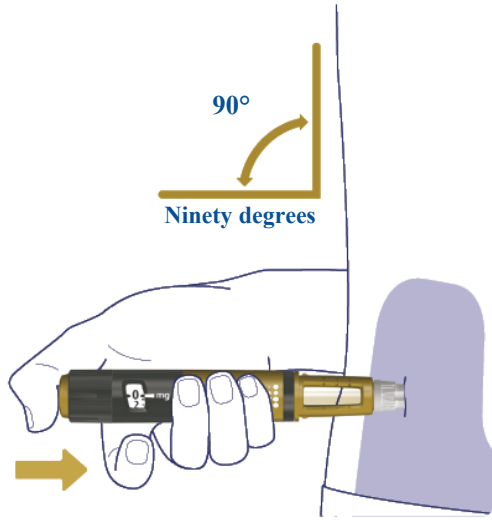

### **Remove the needle                    6**

Remove the needle from your pen by leading the needle tip into the outer needle cap without touching the needle or the cap.

When the needle is covered, carefully push the outer needle cap completely on. Unscrew the needle. Do not touch the back end of the needle.

Dispose of the needle as instructed by your doctor, nurse, pharmacist or local authorities.

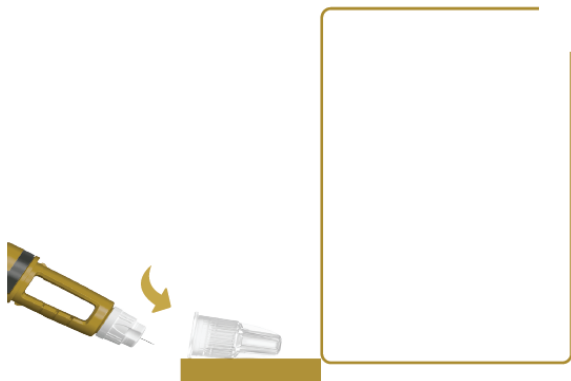

## Do you need a larger dose than you can dial?

If you need a larger dose than you can dial, you must inject yourself more than once to get your full dose. Repeat steps 1 to 6 until you have received your full dose. When you have received your full dose go to step 7.

- Use a new needle for each injection.
- Test the Alhemo flow before each injection.
- Accurately calculate how much to inject in each injection to receive your full dose.

## Completion

7

Put the pen cap back on your pen to protect Alhemo from light.

Now your pen is ready for storage until you need it next time.



### Important information about your pen

- Make sure the pen contains the correct medication.
- Inspect the medication to ensure it is almost clear and colourless to slightly yellow and that no discoloration or solid particles are seen.
- Use a new needle for each injection.
- Pull off both the inner and the outer needle caps before injecting.
- Test the Alhemo flow before each injection.
- Confirm that you have selected the correct dose.
- Insert the needle in the skin of your stomach (abdomen) or thigh in a 90° (ninety degree) angle.
- When injecting, make sure the dose counter returns to <0> and count slowly to 6 after it has returned to <0>.
- If you need a larger dose than you can dial, be accurate when calculating how much to take in each injection.

- Remove the needle from your pen after injection.
- The pen is for single patient use only and must not be shared. Sharing may lead to infection and transmission of disease.
- Follow the instructions from your doctor or nurse on how to use Alhemo and how often you should inject Alhemo.
- After first use do not use your pen for more than 28 days.
- The pen can deliver doses from 1 mg to 80 mg in one injection.

### **Important information about needles**

Needles can be used for one injection only.

Do not re-use needles as this may lead to needle blockage, infection and incorrect dosing.

Never share needles with others.

Designed to be used with NovoFine® 32G TIP ETW or NovoFine® Plus 32G x 4 mm injection needles. If you use needles longer than 4 mm, talk to your doctor or nurse about how to perform your injection.

You can use the outer needle cap to remove the needle from your pen. Put the outer needle cap onto the needle and carefully remove the needle.

Never use a bent or damaged needle.

### **Troubleshooting if no stream appears when testing the flow (step 3)**

- If no stream appears, repeat step 3 up to six times until you see a stream.
- If still no stream appears, prepare a new needle (step 2) and test again (step 3).
- If still no stream appears after using a new needle, do not use the pen. Use a new pen.

### **How much Alhemo is left in your pen?**

The pen scale shows approximately how much Alhemo is left in your pen.

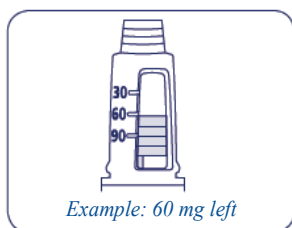

If you want to see more accurately how much Alhemo is left in your pen, turn the dose selector until it stops. The dose pointer will line up with the number of mg left in the pen. The number shown on the dose counter is the number of mg left in your pen.

If the dose counter shows 80, there is 80 mg or more is left in the pen. The example below shows 34 mg of Alhemo left in the pen.

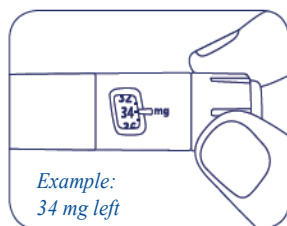

### **Storage**

See how to store your pen in the *Patient Medication Information* on the reverse side of this leaflet.

### **Take good care of your pen**

Do not expose your pen to dust, dirt or liquid.

Do not wash, soak or lubricate your pen. It may be cleaned with a mild detergent on a moistened cloth.

Keep your pen out of sight and reach of others, especially children.

### **Disposing of Alhemo pens, needles and packaging material**

When your pen is empty you must dispose of it according to your local regulations.

You cannot refill your pen.

To reduce the risk of a needle stick, dispose of used needles immediately as instructed by your doctor, nurse, pharmacist or local authorities.

The packaging material (the carton and leaflet) is recyclable.



## INSTRUCTIONS FOR USE

### PrAlhemo™ 300 mg / 3 ml (100 mg / ml) solution for injection in pre-filled pen concizumab injection

For subcutaneous administration only

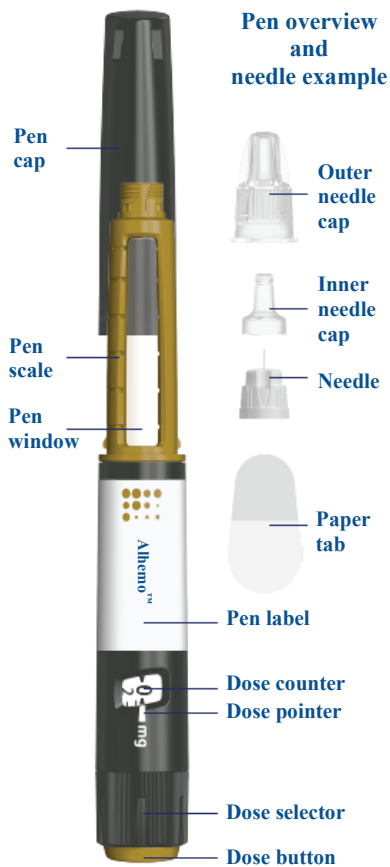

### What is in this package?

- 1 Alhemo pen
- Package leaflet

Read the instructions and make sure you have received training from your doctor or nurse before you use the pen.

Follow the instructions from your doctor or nurse on how to use Alhemo and how often you should inject Alhemo.

The pen is pre-filled with 300 mg of Alhemo for subcutaneous administration only. The pen contains multiple doses of Alhemo.

The pen can deliver a maximum of 80 mg in one injection. The interval on the dose counter is 1 mg. If you need more than 80 mg, you need to inject multiple times.

- Needles are not included. Use compatible injection needles of **4 mm in length**. This pen is designed to be used with NovoFine® 32G TIP ETW or NovoFine® Plus 32G x 4 mm injection needles.

### **Where on my body should I inject my dose?**

You can inject in the skin of:

- your stomach (abdomen) OR
- your thigh.

Inject in a 90° (ninety degree) angle. The grey areas on the picture to the right show the injection sites. For every injection, select a new injection site at least 5 centimetres away from where you last injected.

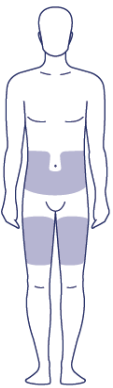

### **Check your pen**                      1

#### **Check pen label**

Look at the name and colour to make sure you have the correct medication.

#### **Check expiration date**

Check the expiration date on the pen label to make sure it has not passed (EXP/MM/YYYY). If the expiration date has passed, do not use the pen.

#### **Inspect medication**

Pull off the pen cap and check that Alhemo in the pen window is almost clear and colourless to slightly yellow. Clear particles might be seen. If Alhemo looks discoloured, or if solid particles are seen, do not use the pen.

#### **If your pen is cold**

You can inject Alhemo right from the refrigerator or let it reach room temperature before you inject. You can warm the pen in the palms of your hands. Do not use any other heating sources.

## Attach a new needle

2

Take a new needle and tear off the paper tab.

- Push the needle straight onto your pen. Turn until it is on tight. See A.
- Pull off the outer needle cap and keep it. See B
- Pull off the inner needle cap and dispose of it. See B.

**Note:** Always use a new needle for each injection.

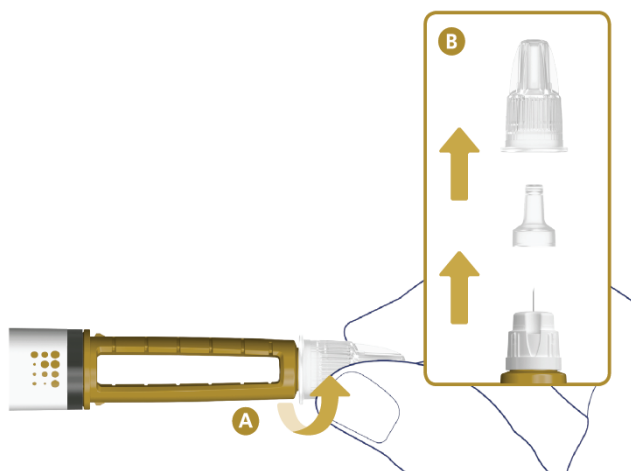

## Dial to '1' and test the flow

3

A drop of Alhemo may appear at the needle tip, but you should still test the Alhemo flow before **each injection** to avoid underdosing:

- Turn the dose selector one marking to select 1 mg. See A.
- Press the dose button. See B.
- Watch a stream of Alhemo leaving the needle tip. See B.

If no stream appears, go to Troubleshooting if no stream appears when testing the flow.

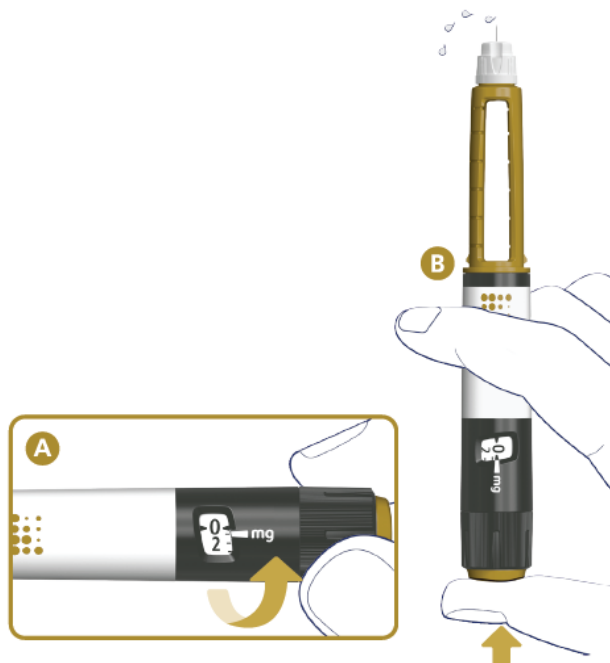

#### Select your dose

4

Turn the dose selector to select your prescribed dose.

You can adjust your dose by turning the dose selector in either direction.

If you need a larger dose than you can dial, you must inject yourself multiple times to get your full dose. For more information, see step 6.

The pen contains 300 mg of Alhemo.

The pen can deliver a maximum of 80 mg in one injection.

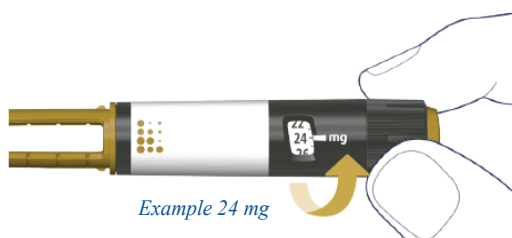

#### Inject your dose

5

Read through steps a. to e. before you start injecting.  
This is to make sure you get your full dose.

- p. Select the injection site. See *Where on my body should I inject my dose?*
- q. Insert the needle straight into your stomach (abdomen) or thigh in a 90° (ninety

- degree) angle.
- r. Press and hold the dose button down until the dose counter returns to **<0>**.
  - s. While the needle is still in your skin, count slowly to 6, after the dose counter has returned to **<0>**.
  - t. Retract the needle from your skin.

The pen clicks during dosing and you might also hear or feel a click when the dose counter returns to **<0>**.

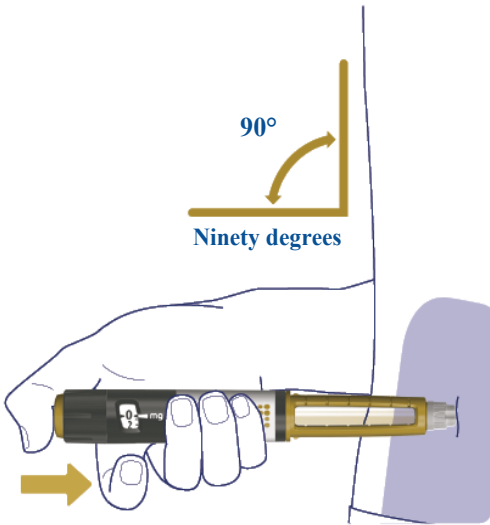

### **Remove the needle 6**

Remove the needle from your pen by leading the needle tip into the outer needle cap without touching the needle or the cap.

When the needle is covered, carefully push the outer needle cap completely on. Unscrew the needle. Do not touch the back end of the needle.

Dispose of the needle as instructed by your doctor, nurse, pharmacist or local authorities.

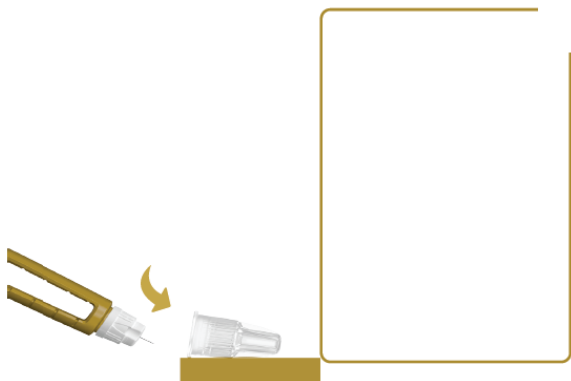

### Do you need a larger dose than you can dial?

If you need a larger dose than you can dial, you must inject yourself more than once to get your full dose. Repeat steps 1 to 6 until you have received your full dose. When you have received your full dose go to step 7.

- Use a new needle for each injection.
- Test the Alhemo flow before each injection.
- Accurately calculate how much to inject in each injection to receive your full dose.

### Completion 7

Put the pen cap back on your pen to protect Alhemo from light.

Now your pen is ready for storage until you need it next time.



### Important information about your pen

- Make sure the pen contains the correct medication.
- Inspect the medication to ensure it is almost clear and colourless to slightly yellow and that no discoloration or solid particles are seen.
- Use a new needle for each injection.
- Pull off both the inner and the outer needle caps before injecting.
- Test the Alhemo flow before each injection.
- Confirm that you have selected the correct dose.
- Insert the needle in the skin of your stomach (abdomen) or thigh in a 90° (ninety degree) angle.
- When injecting, make sure the dose counter returns to <0> and count slowly to 6 after it has returned to <0>.
- If you need a larger dose than you can dial, be accurate when calculating how much to take in each injection.
- Remove the needle from your pen after injection.

- The pen is for single patient use only and must not be shared. Sharing may lead to infection and transmission of disease.
- Follow the instructions from your doctor or nurse on how to use Alhemo and how often you should inject Alhemo.
- After first use do not use your pen for more than 28 days.
- The pen can deliver doses from 1 mg to 80 mg in one injection.

### Important information about needles

Needles can be used for one injection only.

Do not re-use needles as this may lead to needle blockage, infection and incorrect dosing.

Never share needles with others.

Designed to be used with NovoFine® 32G TIP ETW or NovoFine® Plus 32G x 4 mm injection needles. If you use needles longer than 4 mm, talk to your doctor or nurse about how to perform your injection.

You can use the outer needle cap to remove the needle from your pen. Put the outer needle cap onto the needle and carefully remove the needle.

Never use a bent or damaged needle.

### Troubleshooting if no stream appears when testing the flow (step 3)

- If no stream appears, repeat step 3 up to six times until you see a stream.
- If still no stream appears, prepare a new needle (step 2) and test again (step 3).
- If still no stream appears after using a new needle, do not use the pen. Use a new pen.

### How much Alhemo is left in your pen?

The pen scale shows approximately how much Alhemo is left in your pen.

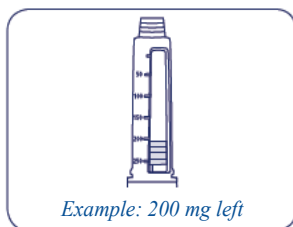

If you want to see more accurately how much Alhemo is left in your pen, turn the dose selector until it stops. The dose pointer will line up with the number of mg left in the pen. The number shown on the dose counter is the number of mg left in your pen.

If the dose counter shows 80, there is 80 mg or more is left in the pen. The example below

shows 34 mg of Alhemo left in the pen.

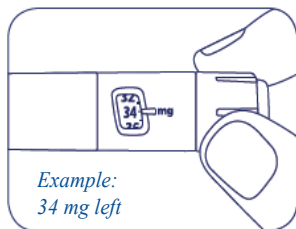

### **Storage**

See how to store your pen in the *Patient Medication Information* on the reverse side of this leaflet.

### **Take good care of your pen**

Do not expose your pen to dust, dirt or liquid.

Do not wash, soak or lubricate your pen. It may be cleaned with a mild detergent on a moistened cloth.

Keep your pen out of sight and reach of others, especially children.

### **Disposing of Alhemo pens, needles and packaging material**

When your pen is empty you must dispose of it according to your local regulations.

You cannot refill your pen.

To reduce the risk of a needle stick, dispose of used needles immediately as instructed by your doctor, nurse, pharmacist or local authorities.

The packaging material (the carton and leaflet) is recyclable.