

PRODUCT MONOGRAPH
INCLUDING PATIENT MEDICATION INFORMATION

^{PR}**WEGOVY**[®]

semaglutide injection

Solution for Subcutaneous Injection in a pre-filled pen

Single-use pre-filled pen delivering doses of 0.25 mg, 0.5 mg, 1 mg, 1.7 mg or 2.4 mg

0.25 mg/pen (0.25 mg/0.5 mL)
0.5 mg/pen (0.5 mg/0.5 mL)
1 mg/pen (1 mg/0.5 mL)
1.7 mg/pen (1.7 mg/0.75mL)
2.4 mg/pen (2.4 mg/0.75mL)

and

Multi-use pre-filled pen (FlexTouch[®]) delivering doses of 0.25 mg, 0.5 mg, 1 mg, 1.7 mg or 2.4 mg

1 mg/pen (0.68 mg/mL)
2 mg/pen (1.34 mg/mL)
4 mg/pen (1.34 mg/mL)
6.8 mg/pen (2.27 mg/mL)
9.6 mg/pen (3.2 mg/mL)

ATC code: A10BJ06

Glucagon-like Peptide-1 (GLP-1) Receptor Agonist

Novo Nordisk Canada Inc.
101-2476 Argentia Road
Mississauga, Ontario
L5N 6M1

Date of Initial Authorization:
November 23, 2021

Date of Revision:
March 22, 2024

Submission Control No: 280250

RECENT MAJOR LABEL CHANGES

1 INDICATIONS	June 2023
4 DOSAGE AND ADMINISTRATION	June 2023
7 WARNINGS AND PRECAUTIONS	June 2023

TABLE OF CONTENTS

Sections or subsections that are not applicable at the time of authorization are not listed.

TABLE OF CONTENTS	2
PART I: HEALTH PROFESSIONAL INFORMATION	4
1 INDICATIONS	4
1.1 Pediatrics	4
1.2 Geriatrics	5
2 CONTRAINDICATIONS	5
3 SERIOUS WARNINGS AND PRECAUTIONS BOX	5
4 DOSAGE AND ADMINISTRATION	5
4.1 Dosing Considerations	5
4.2 Recommended Dose and Dosage Adjustment	6
4.4 Administration	7
4.5 Missed Dose	7
5 OVERDOSAGE	7
6 DOSAGE FORMS, STRENGTHS, COMPOSITION AND PACKAGING	8
7 WARNINGS AND PRECAUTIONS	10
7.1 Special Populations	13
7.1.1 Pregnant Women	13
7.1.2 Breast-feeding	13
7.1.3 Pediatrics	13
7.1.4 Geriatrics	13
7.1.5 Hepatic Insufficiency	13
7.1.6 Renal Insufficiency	14
8 ADVERSE REACTIONS	14
8.1 Adverse Reaction Overview	14
8.2 Clinical Trial Adverse Reactions	14
8.2.1 Clinical Trial Adverse Reactions – Pediatrics	17
8.3 Less Common Clinical Trial Adverse Reactions	17
8.3.1 Less Common Clinical Trial Adverse Reactions – Pediatrics	18
8.4 Abnormal Laboratory Findings: Hematologic, Clinical Chemistry and Other Quantitative Data	18
8.5 Post Market Adverse Reactions	18
9 DRUG INTERACTIONS	18
9.2 Drug Interactions Overview	18
9.4 Drug-Drug Interactions	19
9.5 Drug-Food Interactions	19
9.6 Drug-Herb Interactions	19
9.7 Drug-Laboratory Test Interactions	20

9.8	Drug-Lifestyle Interactions	20
10	CLINICAL PHARMACOLOGY.....	20
10.1	Mechanism of Action	20
10.2	Pharmacodynamics.....	20
10.3	Pharmacokinetics.....	21
11	STORAGE, STABILITY AND DISPOSAL	22
12	SPECIAL HANDLING INSTRUCTIONS	22
PART II: SCIENTIFIC INFORMATION		23
13	PHARMACEUTICAL INFORMATION	23
14	CLINICAL TRIALS.....	23
14.1	Clinical Trials by Indication.....	23
Adults	24
Pediatrics (aged 12 to <18 years)	30
14.3	Immunogenicity	33
15	MICROBIOLOGY	34
16	NON-CLINICAL TOXICOLOGY.....	34
PATIENT MEDICATION INFORMATION		37

PART I: HEALTH PROFESSIONAL INFORMATION

1 INDICATIONS

Wegovy® (semaglutide injection) is indicated as an adjunct to a reduced calorie diet and increased physical activity for chronic weight management in:

- Adult patients with an initial body mass index (BMI) of
 - 30 kg/m² or greater (obesity), or
 - 27 kg/m² or greater (overweight) in the presence of at least one weight-related comorbidity such as hypertension, type 2 diabetes mellitus, dyslipidemia, or obstructive sleep apnea.
- Pediatric patients aged 12 to less than 18 years:
 - with an initial BMI at the 95th percentile or greater for age and sex (obesity; see Table 1), and
 - a body weight above 60 kg (132 lbs), and
 - an inadequate response to reduced calorie diet and physical activity alone.

Limitations of Use

- Wegovy® should not be used in combination with any other semaglutide-containing drug (e.g. Ozempic®, Rybelsus®) or any other GLP-1 receptor agonist.
- The efficacy and safety of Wegovy® in combination with other products intended for weight management, including prescription drugs, over-the-counter drugs, and herbal preparations, have not been established.
- Wegovy® is not indicated for the treatment of Type 1 diabetes mellitus or for the treatment of diabetic ketoacidosis.
- Safety and efficacy data in pediatric (12 to less than 18 years) patients with type 2 diabetes mellitus are limited (see [8.2.1 Clinical Trial Adverse Reactions – Pediatrics, 14 CLINICAL TRIALS](#)).

1.1 Pediatrics

Pediatrics (aged 12 to less than 18 years of age): Based on the data submitted and reviewed by Health Canada, the safety and efficacy of Wegovy® in pediatric patients aged 12 to less than 18 years has been established; therefore, Health Canada has authorized an indication for pediatric use in patients aged 12 to less than 18 years.

The safety and efficacy of Wegovy® in children and adolescents aged 12 to less than 18 years with secondary causes of obesity (i.e., hypothalamic, monogenic, or endocrine causes) has not been studied.

Table 1 shows the age and sex-specific cut-offs for treatment eligibility.

Table 1 BMI (kg/m²) cut-off points for obesity (≥95th percentile) by sex and age for pediatric patients aged 12 to less than 18 years¹

Age (years)	Body Mass Index – 95 th percentile	
	Males	Females
12.0	24.2	25.2
12.5	24.7	25.7
13.0	25.1	26.3
13.5	25.6	26.8
14.0	26.0	27.2
14.5	26.4	27.7
15.0	26.8	28.1

15.5	27.2	28.5
16.0	27.5	28.9
16.5	27.9	29.3
17.0	28.2	29.6
17.5	28.6	30.0

¹ United States Center for Disease Control criteria

1.2 Geriatrics

Geriatrics (> 65 years of age): In the Wegovy[®] clinical trials, 233 (8.8%) Wegovy[®]-treated patients were between 65 and 75 years of age and a limited number (23 [0.9%]) of Wegovy[®]-treated patients were 75 years of age and over. No overall differences in safety or efficacy were detected between these patients and younger patients, but greater sensitivity of older individuals cannot be ruled out.

2 CONTRAINDICATIONS

- Wegovy[®] is contraindicated in patients who are hypersensitive to this drug or to any ingredient in the formulation, including any non-medical ingredient, or component of the container. For a complete listing, see [6 DOSAGE FORMS, STRENGTHS, COMPOSITION AND PACKAGING](#). See also [7 WARNINGS AND PRECAUTIONS](#) and [8 ADVERSE REACTIONS](#).
- Wegovy[®] is contraindicated in patients with a personal or family history of medullary thyroid carcinoma (MTC) or in patients with Multiple Endocrine Neoplasia syndrome type 2 (MEN 2) (see [3 SERIOUS WARNINGS AND PRECAUTIONS BOX](#) and [7 WARNINGS AND PRECAUTIONS](#))
- Wegovy[®] should not be used during pregnancy or breast-feeding (see [7 WARNINGS AND PRECAUTIONS](#))

3 SERIOUS WARNINGS AND PRECAUTIONS BOX

Serious Warnings and Precautions

- In rodents, semaglutide causes dose-dependent and treatment-duration-dependent thyroid C-cell tumours at clinically relevant exposures. It is unknown whether Wegovy[™] causes thyroid C-cell tumours, including medullary thyroid carcinoma (MTC), in humans as human relevance of semaglutide-induced rodent thyroid C-cell tumours has not been determined (see [7 WARNINGS AND PRECAUTIONS](#) and [16 NON-CLINICAL TOXICOLOGY](#)).
- Wegovy[™] is contraindicated in patients with a personal or family history of MTC or in patients with Multiple Endocrine Neoplasia syndrome type 2 (MEN 2) Counsel patients regarding the potential risk for MTC with the use of Wegovy[™] and inform them of symptoms of thyroid tumours (e.g. a mass in the neck, dysphagia, dyspnea, persistent hoarseness). Routine monitoring of serum calcitonin or using thyroid ultrasound is of uncertain value for early detection of MTC in patients treated with Wegovy[™] (see [2 CONTRAINDICATIONS](#), [7 WARNINGS AND PRECAUTIONS](#), [8 ADVERSE REACTIONS](#) AND [16 NON-CLINICAL TOXICOLOGY](#)).

4 DOSAGE AND ADMINISTRATION

4.1 Dosing Considerations

- Wegovy[®] should not be used in combination with any other semaglutide-containing drug (e.g. Ozempic[®], Rybelsus[®]) or any other GLP-1 receptor agonist.

- In patients with Type 2 diabetes mellitus, monitor blood glucose prior to starting and during Wegovy® treatment. Discontinuation of Wegovy® in these patients may result in an increase in blood glucose. Safety and efficacy data in pediatric (12 to less than 18 years) patients with type 2 diabetes mellitus are limited (see [8.2.1 Clinical Trial Adverse Reactions – Pediatrics, 14 CLINICAL TRIALS](#)).
- Wegovy® is not a substitute for insulin.
- Wegovy® should be discontinued in cases of pregnancy, acute pancreatitis, or hypersensitivity reactions.

4.2 Recommended Dose and Dosage Adjustment

Adults and Pediatrics (aged 12 years or older)

The therapeutic and maintenance dose of 2.4 mg semaglutide once-weekly is reached by starting with a dose of 0.25 mg and then following a dose escalation regimen, with dose increases every 4 weeks (to doses of 0.5, 1, 1.7 and 2.4 mg/week) until the therapeutic/maintenance dose of 2.4 mg once-weekly is reached after 16 weeks as shown in Table 2. Follow the dose escalation to reduce the likelihood of gastrointestinal symptoms. If patients do not tolerate a dose during dose escalation, consider delaying dose escalation for 4 weeks.

Table 2 Dose Escalation Schedule

Week 1-4	Week 5-8	Week 9-12	Week 13-16	Week 17 and on
Dose Escalation				Therapeutic/Maintenance Dose
0.25 mg	0.5 mg	1 mg	1.7 mg	2.4 mg

Adults (aged 18 years and older)

If patients do not tolerate the therapeutic/maintenance 2.4 mg dose, the dose can be temporarily decreased to 1.7 mg weekly, for a maximum of 4 weeks. Patients should re-escalate to the therapeutic/maintenance 2.4 mg dose.

Pediatrics (aged 12 to less than 18 years)

For adolescents from the age of 12 to less than 18 years old, the same dose escalation schedule as for adults should be applied (see Table 2). Patients should aim at reaching the maintenance 2.4 mg once-weekly dose following the dose escalation schedule in Table 2.

If patients cannot reach the 2.4 mg dose or do not tolerate 2.4 mg, the patient may remain at a dose level of 1.7 mg once-weekly. Discontinue Wegovy® treatment if the patient cannot tolerate the 1.7 mg once-weekly dose. Evaluate patient progress and reassess continuation of treatment after 12 weeks on the maintenance dose of 2.4 mg or maximum tolerated dose; patients not demonstrating progress by 12 weeks of maintenance treatment are less likely to achieve and sustain clinically meaningful BMI improvement with continued treatment.

Patients with Type 2 diabetes mellitus

Patients with Type 2 diabetes taking sulfonylureas or insulin have an increased risk of hypoglycemia when taking Wegovy®. When initiating Wegovy®, consider reducing the dose of concomitantly administered insulin or insulin secretagogues (such as sulfonylureas) to reduce the risk of hypoglycemia (see [7 WARNINGS AND PRECAUTIONS](#) and [8 ADVERSE REACTIONS](#)).

Geriatrics (> 65 years of age)

From population-PK modeling, no dose adjustment is required based on age (see [10 CLINICAL PHARMACOLOGY](#)). Therapeutic experience of Wegovy® is limited in patients ≥ 75 years of age.

Pediatrics (< 12 years of age)

The efficacy and safety of Wegovy® in pediatric patients aged below 12 years have not been studied. Wegovy® is not indicated for the treatment of pediatric patients below 12 year of age.

Patients with renal insufficiency

Based on population-PK modelling, no dosage adjustment is required for patients with renal insufficiency (see [10 CLINICAL PHARMACOLOGY](#)). Wegovy® is not recommended for use in patients with end-stage renal disease (see [7 WARNINGS AND PRECAUTIONS](#), Renal, Acute Kidney Injury and [10 CLINICAL PHARMACOLOGY](#)).

Patients with hepatic insufficiency

The efficacy and safety of Wegovy® in patients with hepatic insufficiency has not been studied. Therefore, Wegovy® should be used with caution in this patient population (see [10 CLINICAL PHARMACOLOGY](#)).

4.4 Administration

Wegovy® solution should be inspected visually prior to each injection and should be clear, colourless, and contain no particles. Do not use Wegovy® if particulate matter or colouration is seen.

Administer Wegovy® subcutaneously in the abdomen, thigh, or upper arm. Change (i.e. rotate) the site of injection for each administration. The time of day of the injection and the injection site can be changed without dose adjustment. Do not administer Wegovy® intravenously or intramuscularly.

Administer Wegovy® once weekly, on the same day each week, at any time of day, with or without meals.

The day of weekly administration can be changed if necessary, as long as the time between two doses is at least 3 days (≥ 72 hours).

4.5 Missed Dose

If a patient misses one dose and the next scheduled dose is at least 2 days (48 hours) away, instruct the patient to administer Wegovy® as soon as possible. If a patient misses one dose and the next schedule dose is less than 2 days (48 hours) away, inform the patient to not take that dose of Wegovy®. The patients can resume their once-weekly dosing as scheduled.

If a patient misses more than 2 consecutive Wegovy® doses, inform them to resume dosing as scheduled or, if needed, instruct them to reinstate Wegovy® according to the dose escalation schedule, which may reduce the occurrence of gastrointestinal symptoms associated with reinitiation of treatment.

5 OVERDOSAGE

Overdose with semaglutide or other GLP-1 receptor agonists may be associated with severe hypoglycemia, severe nausea and severe vomiting which could lead to dehydration. There is no specific antidote for overdose with Wegovy®. In the event of overdose the patient should be observed for clinical signs and appropriate supportive treatment initiated according to the patient's clinical signs and symptoms. A prolonged period of observation and treatment for these symptoms may be necessary, taking into account the long half-life of semaglutide of

approximately 1 week.

For management of a suspected drug overdose, contact your regional poison control centre.

6 DOSAGE FORMS, STRENGTHS, COMPOSITION AND PACKAGING

To help ensure the traceability of biologic products, including biosimilars, health professionals should recognise the importance of recording both the brand name and the non-proprietary (active ingredient) name as well as other product-specific identifiers such as the Drug Identification Number (DIN) and the batch/lot number of the product supplied.

Table 3 Dosage Forms, Strengths, Composition and Packaging

Route of Administration	Dosage Form / Strength/Composition	Non-medicinal Ingredients
Subcutaneous	Solution for injection in a pre-filled, fixed dose, single-use disposable pen 0.25 mg/pen (0.25 mg/0.5 mL) 0.5 mg/pen (0.5 mg/0.5 mL) 1 mg/pen (1 mg/0.5 mL) 1.7 mg/pen (1.7 mg/0.75mL) 2.4 mg/pen (2.4 mg/0.75mL)	Disodium phosphate dihydrate; Hydrochloric acid; Sodium Chloride; Sodium hydroxide; Water for injection
Subcutaneous	Solution for injection in a pre-filled, fixed dose, multi-use disposable pen (FlexTouch®) 1 mg/pen (0.68 mg/mL) 2 mg/pen (1.34 mg/mL) 4 mg/pen (1.34 mg/mL) 6.8 mg/pen (2.27 mg/mL) 9.6 mg/pen (3.2 mg/mL)	Disodium phosphate, dihydrate; propylene glycol; phenol; Hydrochloric acid; Sodium hydroxide; Water for injection

Wegovy® is a clear and colourless isotonic solution; pH=7.4.

Single-Use Pen

0.25 mg dose pen: Wegovy® is provided in a pre-filled, fixed dose, single-use disposable pen. One mL of solution contains 0.5 mg of semaglutide. One pre-filled pen contains 0.25 mg semaglutide in 0.5 mL

0.5 mg dose pen: Wegovy® is provided in a pre-filled, fixed dose, single-use disposable pen. One mL of solution contains 1 mg of semaglutide. One pre-filled pen contains 0.5 mg semaglutide in 0.5 mL

1 mg dose pen: Wegovy® is provided in a pre-filled, fixed dose, single-use disposable pen. One mL of solution contains 2 mg of semaglutide. One pre-filled pen contains 1 mg semaglutide in 0.5 mL

1.7 mg dose pen: Wegovy® is provided in a pre-filled, fixed dose, single-use disposable pen. One mL of solution contains 2.27 mg of semaglutide. One pre-filled pen contains 1.7 mg semaglutide in 0.75 mL

2.4 mg dose pen: Wegovy® is provided in a pre-filled, fixed dose, single-use disposable pen. One mL of solution contains 3.2 mg of semaglutide. One pre-filled pen contains 2.4 mg of semaglutide in 0.75 mL

The primary packaging contains a 1 mL glass syringe (Type I glass) with attached stainless-steel needle, rigid needle shield (Type II/polyisoprene) and a rubber plunger (Type I/chlorobutyl).

Wegovy® is available in the following package sizes containing disposable, pre-filled, single-use pens:

- 4 x 0.25 mg pens
- 4 x 0.5 mg pens
- 4 x 1 mg pens
- 4 x 1.7 mg pens
- 4 x 2.4 mg pens

Multi-Use Pen

0.25 mg dose pen: Wegovy® is provided in a pre-filled, multi-use disposable pen (FlexTouch®). One mL of solution contains 0.68 mg of semaglutide. One pre-filled pen contains 1 mg semaglutide in 1.5 mL solution.

0.5 mg dose pen: Wegovy® is provided in a pre-filled, multi-use disposable pen (FlexTouch®). One mL of solution contains 1.34 mg of semaglutide. One pre-filled pen contains 2 mg semaglutide in 1.5 mL solution.

1 mg dose pen: Wegovy® is provided in a pre-filled, multi-use disposable pen (FlexTouch®). One mL of solution contains 1.34 mg of semaglutide. One pre-filled pen contains 4 mg semaglutide in 3 mL solution.

1.7 mg dose pen: Wegovy® is provided in a pre-filled, multi-use disposable pen (FlexTouch®). One mL of solution contains 2.27 mg of semaglutide. One pre-filled pen contains 6.8 mg semaglutide in 3 mL solution.

2.4 mg dose pen: Wegovy® is provided in a pre-filled, multi-use disposable pen (FlexTouch®). One mL of solution contains 3.2 mg of semaglutide. One pre-filled pen contains 9.6 mg semaglutide in 3 mL solution.

Each pen contains four doses. Patients should not administer the full volume of the pen at any time.

The primary packaging contains a 1.5 mL or 3 mL glass cartridge (Type I glass) closed at the one end with a rubber plunger (Type I/chlorobutyl) and at the other end with an aluminium cap with a rubber disc (Type I/bromobutyl/isoprene) inserted. The cartridge is assembled into a pre-filled multi-use disposable pen made of polypropylene, polyoxymethylene, polycarbonate and acrylonitrile butadiene styrene.

Disposable needles are included in the Wegovy® (FlexTouch®) package.

Wegovy® is available in the following package sizes containing a disposable, pre-filled, multi-use pen (FlexTouch®):

- 1 x 0.25 mg/dose pen (delivering 4 doses) and 4 disposable needles
- 1 x 0.5 mg/dose pen (delivering 4 doses) and 4 disposable needles
- 1 x 1 mg/dose pen (delivering 4 doses) and 4 disposable needles
- 1 x 1.7 mg/dose pen (delivering 4 doses) and 4 disposable needles

- 1 x 2.4 mg/dose pen (delivering 4 doses) and 4 disposable needles

7 WARNINGS AND PRECAUTIONS

Please see [SERIOUS WARNINGS AND PRECAUTIONS BOX](#).

Carcinogenesis and Mutagenesis

Risk of Thyroid C-Cell Tumours

In mice and rats, semaglutide caused a treatment-duration-dependent increase in the incidence of thyroid C-cell tumours (adenomas and carcinomas) after lifetime exposure at clinically relevant plasma exposures (see [16 NON-CLINICAL TOXICOLOGY](#)). It is unknown whether semaglutide causes thyroid C-cell tumours, including MTC, in humans as human relevance could not be determined. Thyroid C-cell tumours in rodents are a known class effect for GLP-1 receptor agonists.

In clinical trials, there were no cases of MTC observed in patients treated with Wegovy®.

Counsel patients regarding the potential risk for MTC with the use of Wegovy® and inform them of symptoms of thyroid tumours (e.g. a mass in the neck, dysphagia, dyspnea, persistent hoarseness).

It is unknown whether monitoring with serum calcitonin or thyroid ultrasound will mitigate the potential risk of MTC, and such monitoring may increase the risk of unnecessary procedures, due to low test specificity for serum calcitonin and a high background incidence of thyroid disease. Patients with thyroid nodules noted on physical examination or neck imaging obtained for other reasons should be referred to an endocrinologist for further evaluation. Although routine monitoring of serum calcitonin is of uncertain value in patients treated with Wegovy® if serum calcitonin is measured and found to be elevated, the patient should be referred to an endocrinologist for further evaluation.

Wegovy® is contraindicated in patients with a personal or family history of medullary thyroid carcinoma (MTC) or in patients with Multiple Endocrine Neoplasia syndrome type 2 (MEN 2).

Cardiovascular

Heart Rate Increase

Semaglutide causes an increase in heart rate (see [8.2.1 Clinical Trial Adverse Reactions-Pediatrics](#), [10 CLINICAL PHARMACOLOGY](#)). Caution should be observed in patients who have cardiac conditions that might be worsened by an increase in heart rate, such as tachyarrhythmias (see [9 DRUG INTERACTIONS](#)). Monitor heart rate at regular intervals consistent with usual clinical practice. Instruct patients to inform their healthcare professional of palpitations or feelings of a racing heartbeat while at rest during Wegovy® treatment. If patients experience a sustained increase in resting heart rate, discontinue Wegovy.

PR Interval Prolongation

Semaglutide causes a prolongation of the PR interval of the electrocardiogram (see [10 CLINICAL PHARMACOLOGY](#)). Caution should be observed in patients with pre-existing conduction system abnormalities (e.g., marked first-degree AV block or second- or third-degree AV block) or a history of rhythm disturbances (e.g., tachyarrhythmias).

Heart Failure

Patients with New York Heart Association (NYHA) Class IV heart failure were excluded from the Wegovy® clinical trials. The use of Wegovy® in these patients is not recommended.

Driving and Operating Machinery

If Wegovy[®] is used in combination with a sulfonylurea or insulin, patients should be advised to take precautions to avoid hypoglycemia while driving and using machines (see [8 ADVERSE REACTIONS](#)).

Endocrine and Metabolism

Hypoglycemia

Wegovy[®] lowers blood glucose and can cause hypoglycemia. Patients with type 2 diabetes mellitus taking Wegovy[®] with insulin or an insulin secretagogue (such as sulfonylureas) may have an increased risk of hypoglycemia, including severe hypoglycemia (see [8 ADVERSE REACTIONS](#)). When initiating Wegovy[®], consider reducing the dose of concomitantly administered insulin or insulin secretagogues. Inform patients of the risk of hypoglycemia and instruct them about the signs and symptoms of hypoglycemia. In patients with type 2 diabetes mellitus, monitor blood glucose prior to starting Wegovy[®] and during Wegovy[®] treatment. Safety and efficacy data in pediatric (12 to less than 18 years) patients with type 2 diabetes mellitus are limited (see 8.2.1 Clinical Trial Adverse Reactions – Pediatrics, 14 CLINICAL TRIALS).

Gastrointestinal

Use of Wegovy[®] is associated with gastrointestinal adverse reactions that can cause dehydration, which can lead to a deterioration of renal function. Patients should be advised of the potential risk of dehydration in relation to gastrointestinal side effects and take precautions to avoid fluid depletion (see **Renal Acute Kidney Injury** below and [8 ADVERSE REACTIONS](#)).

Delayed Gastric Emptying

Use of GLP-1 receptor agonists may be associated with severe gastrointestinal disease (intestinal obstruction and ileus) (see [8.5 Post Market Adverse Reactions](#)).

Events of intestinal obstruction and ileus have been reported in the post-marketing database with an unknown frequency.

Hepatic/Biliary/Pancreatic

Acute Pancreatitis

Cases of acute pancreatitis, including fatal and non-fatal hemorrhagic or necrotizing pancreatitis, have been observed in patients treated with GLP-1 receptor agonists, including semaglutide (see [8 ADVERSE REACTIONS](#)). In the four main Wegovy[®] clinical trials, acute pancreatitis was confirmed by adjudication in 4 Wegovy[®]-treated patients (0.2 cases per 100 patient years) versus 1 in placebo-treated patients (less than 0.1 cases per 100 patient years). One additional case of acute pancreatitis was confirmed in a Wegovy[®]-treated patient in another clinical trial.

After initiation of Wegovy[®], observe patients carefully for signs and symptoms of acute pancreatitis (including persistent severe abdominal pain, sometimes radiating to the back and which may or may not be accompanied by vomiting). If acute pancreatitis is suspected, Wegovy[®] should promptly be discontinued and appropriate management should be initiated. If acute pancreatitis is confirmed, Wegovy[®] should not be restarted. Wegovy[®] has not been studied in patients with a history of chronic pancreatitis or a recent (past 6 months) history of acute pancreatitis; therefore caution is warranted in this population.

Acute Gallbladder Disease

In Wegovy[®] randomized clinical trials in adults, cholelithiasis was reported by 1.6% of Wegovy[®]-treated patients and 0.7% of placebo-treated patients. Cholecystitis was reported by 0.6% of Wegovy[®]-treated patients and 0.2% of placebo-treated patients. In a clinical trial in pediatric patients aged 12 to less than 18 years, cholelithiasis was reported by 3.8% of

Wegovy[®]-treated patients and by no placebo-treated patients. Cholecystitis was reported by 0.8% of Wegovy[®]-treated patients and by no placebo-treated patients.

Substantial or rapid weight loss can increase the risk of cholelithiasis; however, the incidence of acute gallbladder disease was greater in Wegovy[®]-treated patients than in placebo-treated patients, even after accounting for the degree of weight loss. If cholelithiasis is suspected, gallbladder studies and appropriate clinical follow-up are indicated (see [8 ADVERSE REACTIONS](#)).

Immune

Hypersensitivity/allergy

Severe, life-threatening, generalized allergic reactions, including anaphylaxis, have occurred with semaglutide ([8 ADVERSE REACTIONS](#)). If a hypersensitivity reaction occurs, the patient should discontinue Wegovy[®] and promptly seek medical advice. Do not use in patients with a previous hypersensitivity reaction to semaglutide or to any ingredient in the formulation, including any non-medicinal ingredient, or component of the container.

Ophthalmologic

Retinal Disorders (including Diabetic Retinopathy) in Patients with Type 2 Diabetes

Retinal disorders, including diabetic retinopathy, have been reported in Wegovy[™]-treated patients (see [8 ADVERSE REACTIONS](#)). Rapid improvement in glucose control has been associated with a temporary worsening of diabetic retinopathy. The effect of long-term glycemic control with semaglutide on diabetic retinopathy complications has not been studied. Patients with a history of diabetic retinopathy should be monitored for progression of diabetic retinopathy.

Psychiatric

Suicidal Behaviour and Ideation

Patients with a history of suicidal behaviour or major depressive disorder, or a recent history of suicidal ideation were excluded from the clinical trials for Wegovy[®]. Do not use Wegovy[®] in patients with a history of suicidal attempts or active suicidal ideation. Patients treated with Wegovy[®] should be monitored for the emergence or worsening of depression, suicidal thoughts or behaviour and/or any unusual changes in mood or behaviour. Discontinue Wegovy[®] in patients who experience suicidal thoughts or behaviours.

Renal

Acute Kidney Injury

In patients treated with semaglutide, there have been post-marketing reports of acute renal failure and worsening of chronic renal failure, which may sometimes require hemodialysis. Patients with renal impairment may be at greater risk of acute renal injury, but some of these events were reported in patients without known underlying renal disease. A majority of the reported events occurred in patients who had experienced gastrointestinal events (e.g. nausea, vomiting or diarrhea) leading to volume depletion (see [8 ADVERSE REACTIONS](#)). Monitor renal function in patients with renal insufficiency reporting severe adverse gastrointestinal reactions that could lead to volume depletion. Monitor renal function when initiating or escalating doses of Wegovy[®] in patients with severe gastrointestinal reactions.

Reproductive Health: Female and Male Potential

It is recommended that patients use contraception when treated with semaglutide if they are at risk of becoming pregnant. If a patient wishes to become pregnant, or pregnancy occurs, discontinue semaglutide treatment. Discontinue semaglutide at least 2 months before a planned pregnancy due to its long half-life (see [10 CLINICAL PHARMACOLOGY](#)).

Fertility

The effect of semaglutide on fertility in humans is unknown. In female rats, following administration of subcutaneous semaglutide, an increase in oestrous length and a small reduction in number of ovulations were observed at doses associated with maternal body weight loss (see [16 NON-CLINICAL TOXICOLOGY](#)).

7.1 Special Populations

7.1.1 Pregnant Women

Wegovy[®] is contraindicated during pregnancy (see [2 CONTRAINDICATIONS](#)). Weight loss offers no benefit to a pregnant woman and may result in fetal harm. A minimum weight gain, and no weight loss, is recommended for all pregnant women, including those who are already overweight or have obesity, due to the necessary weight gain that occurs in maternal tissues during pregnancy. There have been no studies conducted in pregnant women with Wegovy[®]. If a patient wishes to become pregnant, or pregnancy occurs, discontinue semaglutide treatment. Discontinue semaglutide at least 2 months before a planned pregnancy due to its long half-life (see [10 CLINICAL PHARMACOLOGY](#)).

Use of Wegovy[®] during pregnancy may cause fetal harm based on animal studies. Animal studies with subcutaneous semaglutide have shown reproductive and developmental toxicity at exposures below or similar to human exposure levels. Adverse developmental effects included fetal malformations in rats, rabbits, and monkeys and pre- and post-natal losses in monkeys (see [16 NON-CLINICAL TOXICOLOGY](#)).

7.1.2 Breast-feeding

It is unknown if Wegovy[®] is excreted in human milk. Animal studies have shown that semaglutide was excreted in the milk of lactating rats. A risk to a breast-fed child cannot be excluded. Semaglutide is contraindicated during breast-feeding (see [2 CONTRAINDICATIONS](#)).

7.1.3 Pediatrics

The efficacy and safety of Wegovy[®] in children and adolescents below 12 years have not been studied. Wegovy[®] is not indicated for use in pediatric patients below 12 years of age.

7.1.4 Geriatrics

In the Wegovy[®] clinical trials, 233 (8.8%) Wegovy[®]-treated patients were between 65 and 75 years of age and 23 (0.9%) Wegovy[®]-treated patients were 75 years of age and over. No overall differences in safety or efficacy were detected between these patients and younger patients, but greater sensitivity of older individuals cannot be ruled out.

7.1.5 Hepatic Insufficiency

The efficacy and safety of Wegovy[®] in patients with hepatic insufficiency has not been studied. Therefore, Wegovy[®] should be used with caution in this patient population (see [10 CLINICAL PHARMACOLOGY](#)).

7.1.6 Renal Insufficiency

Experience with the use of Wegovy® in patients with severe renal impairment is limited. Wegovy® is not recommended for use in patients with end-stage renal disease (see [7 WARNINGS AND PRECAUTIONS](#), Renal, Acute Kidney Injury and [10 CLINICAL PHARMACOLOGY](#)).

8 ADVERSE REACTIONS

8.1 Adverse Reaction Overview

In the controlled weight management trials in adults, serious adverse events were more common with Wegovy® (9.7% vs 6.5%) compared to placebo. In adolescent patients (aged 12 to <18 years), serious adverse events occurred in 11.3% of patients treated with Wegovy® and 9.0% of patients treated with placebo.

In controlled clinical trials in adults, 6.8% of patients treated with Wegovy® and 3.2% of patients treated with placebo prematurely discontinued treatment permanently due to adverse events. In adolescent patients, 4.5% of patients discontinued treatment permanently due to adverse events in both the Wegovy® and placebo arms.

The most frequently reported adverse reactions in clinical trials in adult patients (occurring in ≥10% of Wegovy® treated patients) were nausea (44% in Wegovy® vs 16% in placebo), diarrhea (30% vs 16%), vomiting (24% vs 6.3%), constipation (24% vs 11%), abdominal pain (20% vs 10%), headache (16% vs 11%) and fatigue (11% vs 5.1%).

The most frequently reported adverse reactions in clinical trials in adolescent patients were nausea (42.1% in Wegovy® vs 17.9% in placebo), vomiting (36.1% vs 10.4%), diarrhea (21.8% vs 19.4%), headache (16.5% vs 16.4%), and abdominal pain (15.0% vs 6.0%).

Overall, the frequency, type, and severity of adverse reactions in the adolescents were comparable to that observed in the adult population.

The following serious adverse reactions are described below or elsewhere in the Product Monograph (see [7 WARNINGS AND PRECAUTIONS](#)):

- Risk of Thyroid C-Cell Tumors
- Acute Pancreatitis
- Acute Gallbladder Disease
- Retinal Disorders (including Diabetic Retinopathy) in Patients with Type 2 Diabetes
- Hypoglycemia
- Acute Kidney Injury
- Hypersensitivity Reactions

8.2 Clinical Trial Adverse Reactions

Because clinical trials are conducted under very specific conditions, the adverse reaction rates observed in the clinical trials may not reflect the rates observed in practice and should not be compared to the rates in the clinical trials of another drug. Adverse reaction information from clinical trials is useful for identifying drug-related adverse events and for approximating rates.

Wegovy® was evaluated for safety in 3 randomized, double-blind, placebo-controlled trials that included 2116 adult patients treated with semaglutide 2.4 mg once-weekly for up to 68 weeks. [See [8.2.1 Clinical Trial Adverse Reactions – Pediatrics](#) for data in adolescent patients.] The trials evaluated weight management with semaglutide 2.4 mg as an adjunct to

a reduced-calorie diet and increased physical activity. STEP 1 and 3 included patients with obesity or overweight with at least one weight-related comorbidity (not T2D). STEP 2 included patients with T2D and with either obesity or overweight (403 Wegovy[®]-treated patients). Baseline characteristics included a mean age of 48 years, 71% women, 72% White, 42% with hypertension, 19% with type 2 diabetes, 43% with dyslipidemia, 28% with a BMI greater than 40 kg/m², and 4% with cardiovascular disease.

Table 4 shows common adverse reactions associated with the use of Wegovy[®] in the pool of placebo-controlled trials in adults. These adverse reactions occurred more commonly on Wegovy[®] than on placebo, and occurred in at least 1% of patients treated with Wegovy[®].

Table 4 Adverse reactions (regardless of causality) Reported in ≥1% of Patients Receiving Wegovy[®] (semaglutide 2.4 mg) and More Frequently than in the Placebo Group in Three 68-week, Placebo-Controlled Trials in Adults (STEP 1-3)

	Placebo N=1261 %	Wegovy [®] N=2116 %
Gastrointestinal Disorders		
Nausea	16	44
Diarrhea	16	30
Vomiting	6.3	24
Constipation	11	24
Abdominal Pain ^a	10	20
Dyspepsia	3.2	9.0
Abdominal Distension	5.1	7.0
Eructation	0.4	7.4
Flatulence	4.2	5.9
Gastroesophageal Reflux Disease	3.0	5.4
Gastritis ^b	1.3	3.6
Hemorrhoids	0.4	2.1
General disorders and administration site conditions		
Fatigue ^c	5.1	11
Injection Site Reactions ^d	1.0	1.4
Hepatobiliary disorders		
Cholelithiasis	0.7	1.6
Metabolism and nutrition disorders		
Decreased Appetite	3.0	9.3
Nervous system disorders		
Headache ^e	11	16
Dizziness	3.8	7.7
Dysgeusia ^h	0.5	1.8
Skin and subcutaneous tissue disorders		
Hair Loss ^f	1.4	3.3
Vascular disorders		
Hypotension ^g	0.4	1.3

^aIncludes abdominal pain, abdominal pain upper, abdominal pain lower, gastrointestinal pain, abdominal tenderness, abdominal discomfort and epigastric discomfort

^bIncludes chronic gastritis, gastritis, gastritis erosive, and reflux gastritis

^cIncludes fatigue and asthenia

^dIncludes preferred terms Injection site reaction, Injection site pruritus, Injection site erythema, Injection site inflammation, Injection site paraesthesia, Injection site induration, Injection site swelling, Injection site urticaria, Injection site irritation

^eIncludes migraine, migraine with aura, headache

^fpreferred term alopecia

^gIncludes hypotension, orthostatic hypotension and decreased blood pressure

^hIncludes dysgeusia and taste disorder

Gastrointestinal Disorders

In clinical trials with adult patients, gastrointestinal disorders were reported more frequently in Wegovy[®]-treated patients than placebo-treated patients (Wegovy[®] 73%, placebo 47%). Most episodes of gastrointestinal events were mild or moderate, of short duration and did not lead to discontinuation of Wegovy[®]. The events of constipation were mild to moderate in severity and were of longer duration. In Wegovy[®]-treated adult patients, median duration of nausea was 8 days, vomiting 2 days, diarrhea 3 days, and constipation 47 days (see [7 WARNINGS AND PRECAUTIONS](#)). Permanent discontinuation of treatment as a result of a gastrointestinal adverse reaction occurred in 4.3% of Wegovy[®]-treated patients versus 0.7% of placebo-treated patients (see [7 WARNINGS AND PRECAUTIONS](#)). In a clinical trial in adolescent patients, gastrointestinal disorders occurred with a similar frequency and profile as with adults (see 8.2.1 Clinical Trial Adverse Reactions – Pediatrics).

Cholelithiasis and Cholecystitis

In clinical trials, cholelithiasis was reported in 1.6% of Wegovy[®]-treated adult patients and 0.7% of placebo-treated adult patients. Cholecystitis was reported in 0.6% of Wegovy[®]-treated adult patients and 0.2% of placebo-treated adult patients (see [7 WARNINGS AND PRECAUTIONS](#)). In a clinical trial in pediatric patients aged 12 to less than 18 years, cholelithiasis was reported by 3.8% of Wegovy[®]-treated patients and by no placebo-treated patients. Cholecystitis was reported by 0.8% of Wegovy[®]-treated patients and by no placebo-treated patients.

Hair Loss/Alopecia

Alopecia was reported more frequently in Wegovy[®]-treated adult patients losing \geq 20% compared to those losing < 20% of their initial body weight (5.3% vs 2.5%).

Retinal disorders (including Diabetic Retinopathy) in patients with Type 2 Diabetes

In a trial of patients with type 2 diabetes and BMI greater than or equal to 27 kg/m², retinal disorders were reported by 6.9% of Wegovy[®]-treated patients, 6.2% of patients treated with semaglutide 1 mg SC, and 4.2% of patients treated with placebo. Of these, the majority were reported as diabetic retinopathy (4.0%, 2.7%, and 2.7%, respectively) and non-proliferative retinopathy (0.7%, 0%, and 0%, respectively) (see [7 WARNINGS AND PRECAUTIONS](#)). The study in pediatric (aged 12 to <18 years) patients did not include a sufficient number of subjects with Type 2 Diabetes to assess the incidence of retinal disorders.

Hypoglycemia in patients with Type 2 Diabetes

In a trial of patients with type 2 diabetes and BMI greater than or equal to 27 kg/m², hypoglycemia (defined as a plasma glucose less than 3.0 mmol/L) was reported in 6.2% of Wegovy[®]-treated patients versus 2.5% of placebo-treated patients. One episode of severe hypoglycemia was reported in a Wegovy[®]-treated patient. The risk of hypoglycemia was increased when Wegovy[®] was used with a sulfonylurea (see [7 WARNINGS AND PRECAUTIONS](#)). The study in pediatric (aged 12 to <18 years) patients did not include a sufficient number of subjects with Type 2 Diabetes to assess the incidence of hypoglycemia.

Hypoglycemia in patients without Type 2 Diabetes

Episodes of hypoglycemia have been reported with GLP-1 receptor agonists in patients without type 2 diabetes mellitus. The Wegovy[®] clinical trials in patients without type 2 diabetes mellitus did not systematically capture or report hypoglycemia episodes.

Acute Kidney Injury

Acute kidney injury occurred in clinical trials in 7 Wegovy[®]-treated patients (0.4 cases per

100 patient years) versus 4 placebo-treated patients (0.2 cases per 100 patient years of exposure). Some of these adverse reactions occurred in association with gastrointestinal adverse reactions or dehydration. In addition, 2 Wegovy[®]-treated patients had acute kidney injury with dehydration in other clinical trials. The risk of renal adverse reactions with Wegovy[®] was increased in patients with a history of renal impairment (trials included 65 patients with a history of moderate or severe renal impairment at baseline), and occurred more frequently during dose titration (see [8.3 Less Common Clinical Trial Adverse Reactions](#)).

8.2.1 Clinical Trial Adverse Reactions – Pediatrics

Wegovy[®] was evaluated for safety in 1 randomized, double-blind, placebo-controlled trial that included 133 adolescents with obesity ($\geq 95^{\text{th}}$ percentile for age and sex) exposed to Wegovy[®]. Patients were 62.7% female with a mean age of 15.5 years (range 12-18) at study entry and a mean baseline body weight of 109.9 kg (range 61.6-211.9 kg).

Patients were treated for up to 68 weeks with the recommended maintenance dose of semaglutide 2.4 mg (or highest tolerated dose) once-weekly following a dose escalation phase, as an adjunct to a reduced calorie diet and increased physical activity. There were 120 (89.6 %) patients who completed the treatment, out of which 26 (21.7%) required 2 or more consecutive doses < 2.4 mg/week due to tolerability issues.

Overall, the frequency, type, and severity of adverse reactions in the adolescents were comparable to that observed in the adult population. Consistent with use in adult patients, the most common adverse reactions in adolescent patients were gastrointestinal disorders, which occurred in 61.7% of Wegovy[®] treated patients and 41.8% of placebo treated patients. The prevalence of gastrointestinal adverse events was highest during the dose escalation phase of treatment.

See subsections under [8.2 Clinical Trial Adverse Reactions](#) for details on adverse events of special interest for Wegovy[®] in adolescent patients. Cholelithiasis, an adverse events of special interest, occurred more frequently in adolescents than in adults (3.8% of Wegovy-treated adolescents, compared to 1.6% of Wegovy-treated adults).

There were 5 patients exposed to Wegovy[®] (3.7%) and 3 to placebo (4.5%) who had pre-existing type 2 diabetes mellitus. Sample size was inadequate to draw conclusions on relative safety in this subset of adolescent patients but did not appear to differ substantially from non-diabetic patients.

No clinically relevant treatment differences were noted in adolescent patients with respect to growth or pubertal development.

8.3 Less Common Clinical Trial Adverse Reactions

The adverse reactions listed below occurred in less than 1% of patients, and occurred more frequently in Wegovy[®]-treated patients than those on placebo.

Cardiac disorders: Increased heart rate

Gastrointestinal disorders: Acute pancreatitis, Appendicitis

Nervous system disorders: Syncope

Immune system disorders: Anaphylactic Reaction

Investigations: Increased amylase, Increased lipase

Renal and urinary disorders: Acute kidney injury

Skin and subcutaneous tissue disorders: Angioedema

8.3.1 Less Common Clinical Trial Adverse Reactions – Pediatrics

The adverse reactions listed below occurred in less than 1% of adolescent patients, and occurred more frequently in Wegovy[®]-treated patients than those on placebo.

Cardiac disorders: Increased heart rate

Investigations: Increased amylase

8.4 Abnormal Laboratory Findings: Hematologic, Clinical Chemistry and Other Quantitative Data

Amylase and Lipase

Amylase and lipase were measured in the clinical trials. Adult patients treated with Wegovy[®] had a mean increase from baseline in amylase of 16% and in lipase of 39%; increases in adolescent patients were similar to those in adults. The percentage of patients with values above 3 times the upper limit of normal for amylase or lipase at any timepoint on-treatment after baseline are presented below. The clinical significance of elevations of amylase or lipase in patients without other signs and symptoms of pancreatitis is unknown. (see [7 WARNINGS AND PRECAUTIONS](#)).

Table 5 Amylase and lipase

	Wegovy [®] N = 2116 N (%)	Placebo N = 1261 N (%)
Amylase > 3X ULN	1 (< 0.1)	0
Lipase > 3X ULN	26 (1.2)	10 (0.8)

%; percentage of patients; N: number of patients; ULN: upper limit of normal

Increased Heart Rate

In the adult phase 3a trials, a mean increase of 3 beats per minute (bpm) from a baseline mean of 72 bpm was observed in patients treated with Wegovy[®]. The proportions of adult patients with an increase from baseline \geq 20 bpm at any time point during the on-treatment period were 26% in the Wegovy[®] group vs 16% in the placebo group. In the study in adolescent patients, the proportion of patients with an increase in heart rate of \geq 20 bpm at any time point was 36.4% in the Wegovy[®] arm and 33.3% in the placebo arm.

8.5 Post Market Adverse Reactions

The following additional adverse reactions have been reported during post-approval use of Wegovy[®]. Because these events are reported voluntarily from a population of uncertain size, it is generally not possible to reliably estimate their frequency or establish a causal relationship to drug exposure.

Gastrointestinal disorders: delayed gastric emptying, intestinal obstruction and ileus

9 DRUG INTERACTIONS

9.2 Drug Interactions Overview

As with other GLP-1 receptor agonists, semaglutide may delay gastric emptying and could potentially influence the absorption of concomitantly administered oral medicinal products. In a pharmacodynamic study, no clinically relevant effect on the rate of gastric emptying was

observed with semaglutide 2.4 mg. In clinical pharmacology trials assessing the effect of semaglutide 1 mg on the absorption of co-administered oral medications at steady state no clinically relevant drug-drug interactions with semaglutide was observed based on the evaluated medications.

9.4 Drug-Drug Interactions

The drugs listed in this table are based on either drug interaction case reports or studies, or potential interactions due to the expected magnitude and seriousness of the interaction (i.e., those identified as contraindicated).

Table 6 Established or Potential Drug-Drug Interactions

Semaglutide	Source of Evidence	Effect	Clinical comment
Atorvastatin	CT	No clinically relevant change in AUC or C _{max}	None
Oral Contraceptives (containing ethinylestradiol and levonorgestrel)			
Digoxin	CT	Semaglutide did not change AUC or C _{max}	None
Metformin			
Warfarin (S-warfarin and R-warfarin)			

Legend: C = Case Study; CT = Clinical Trial; T = Theoretical

No dose adjustment is required for these oral medications when co-administered with semaglutide.

Drugs that Increase Heart Rate

Wegovy[®] causes an increase in heart rate (see [7 WARNINGS AND PRECAUTIONS](#) and [10 CLINICAL PHARMACOLOGY](#)). The impact on heart rate of co-administration of Wegovy[®] with other drugs that increase heart rate (e.g., sympathomimetic drugs) has not been evaluated in drug-drug interaction studies. As a result, co-administration of Wegovy[®] with these drugs should be undertaken with caution.

Drugs that Cause PR Interval Prolongation

Wegovy[®] causes an increase in the PR interval (see [7 WARNINGS AND PRECAUTIONS](#) and [10 CLINICAL PHARMACOLOGY](#)). The impact on the PR interval of co-administration of Wegovy[®] with other drugs that prolong the PR interval (including, but not limited to, antiarrhythmics, calcium channel blockers, beta-adrenoceptor blockers, digitalis glycosides, HIV protease inhibitors) has not been evaluated. As a result, co-administration of Wegovy[®] with these drugs should be undertaken with caution.

9.5 Drug-Food Interactions

Interactions with food have not been established.

9.6 Drug-Herb Interactions

Interactions with herbal products have not been established.

9.7 Drug-Laboratory Test Interactions

Interactions with laboratory tests have not been established.

9.8 Drug-Lifestyle Interactions

Wegovy[®] has no or negligible influence on the ability to drive or use machines. However, dizziness can be experienced mainly during the dose escalation period. Driving or use of machines should be avoided if dizziness occurs. In patients with Type 2 Diabetes, when Wegovy[®] is used in combination with a sulfonylurea or insulin, patients should be advised to take precautions to avoid hypoglycemia while driving and using machines.

10 CLINICAL PHARMACOLOGY

10.1 Mechanism of Action

Semaglutide is 94% similar to human GLP-1 and acts as a GLP-1 receptor agonist that binds to and activates GLP-1 receptors. Compared to native GLP-1, semaglutide has a prolonged half-life of around 1 week. The principal mechanism of protraction is albumin binding, which results in decreased renal clearance and protection from metabolic degradation. Furthermore, semaglutide is stabilised against degradation by the DPP-4 enzyme.

GLP-1 is a physiological regulator of appetite and caloric intake, and the GLP-1 receptor is present in several areas of the brain involved in appetite regulation. Animal studies show that semaglutide distributed to and activated neurons in some brain regions involved in regulation of food intake.

10.2 Pharmacodynamics

Appetite regulation and energy intake

Semaglutide lowers bodyweight by decreasing energy intake, likely mediated via a change in appetite.

Glucose-lowering effect

In clinical studies 1 mg semaglutide has been shown to reduce blood glucose through a mechanism where it stimulates insulin secretion and lowers glucagon secretion, both in a glucose-dependent manner.

Cardiac electrophysiology

QTc Interval: The effect of 2.4 mg subcutaneous semaglutide on cardiac repolarization has not been directly tested in a QTc trial. However, semaglutide did not prolong QTc intervals at dose levels up to 1.5 mg at steady state.

Heart Rate: Treatment with subcutaneous semaglutide was associated with an increase in heart rate at all dose levels (see [7 WARNINGS AND PRECAUTIONS](#) and [9 DRUG INTERACTIONS](#)).

PR Interval: Treatment with subcutaneous semaglutide causes PR interval prolongation, with no evidence of dose-dependency over the 0.5 to 1.5 mg dose range studied (see [7 WARNINGS AND PRECAUTIONS](#) and [9 DRUG INTERACTIONS](#)).

10.3 Pharmacokinetics

Table 7 – Summary of observed semaglutide 2.4 mg pharmacokinetic parameters in patients with BMI 27.0-34.9 kg/m² in a clinical pharmacology trial

	C_{max}	t_{max}	t_{1/2}	AUC_{0-168h}	CL/F	V_{ss/F}
Steady state	119 nmol/L	24 h	155 h	14698 nmol*h/L	0.040 L/h	9.8 L

All values are geometric mean (except for median t_{max})

Absorption: Absolute bioavailability of semaglutide is 89%. Maximum concentration of semaglutide is reached 1 to 3 days post dose.

Similar exposure was achieved with s.c. administration of semaglutide in the abdomen, thigh, or upper arm.

Based on population PK modelling, the average semaglutide steady state concentration following s.c. administration of Wegovy[®] was approximately 75 nmol/L in patients with either excess weight (BMI ≥27 kg/m² to <30 kg/m²) or obesity (BMI ≥ 30 kg/m²). The steady state exposure of semaglutide increased proportionally with doses up to 2.4 mg once weekly.

Distribution: Based on population PK modelling, the mean volume of distribution of semaglutide following s.c. administration in patients with excess weight or obesity is approximately 12.4 L. Semaglutide is extensively bound to plasma albumin (> 99%).

Metabolism: Semaglutide is metabolised through proteolytic cleavage of the peptide backbone and sequential beta-oxidation of the fatty acid side chain.

Elimination: Semaglutide has pharmacokinetic properties compatible with once-weekly administration, with an elimination half-life of approximately 1 week.

The primary excretion routes of semaglutide-related material are via the urine and feces. Approximately 3% of the dose was excreted in the urine as intact semaglutide.

Clearance of semaglutide in patient with excess weight (BMI ≥27 kg/m² to <30 kg/m²) or obesity (BMI ≥ 30 kg/m²) was approximately 0.05 L/h based on population PK modelling. With an elimination half-life of approximately 1 week, semaglutide can be present in the circulation for approximately 7 weeks after the last dose of 2.4 mg.

Special Populations and Conditions

Based on a population pharmacokinetic analysis, age, sex, race, ethnicity, renal impairment (mild or moderate), and glycemic status do not have a clinically meaningful effect on the pharmacokinetics of semaglutide. The exposure of semaglutide decreases with an increase in body weight. However, semaglutide 2.4 mg provides adequate systemic exposure over the body weight range of 54.4-245.6 kg evaluated in the clinical trials.

Hepatic Insufficiency

Hepatic insufficiency did not have any impact on the exposure of semaglutide. The pharmacokinetics of semaglutide were evaluated in patients with different degrees of hepatic insufficiency (mild, moderate, severe) compared with patients with normal hepatic function in a study with a single-dose of 0.5 mg semaglutide.

Renal Insufficiency

Renal insufficiency did not impact the pharmacokinetics of semaglutide in a clinically relevant manner. This was shown with a single dose of 0.5 mg semaglutide for patients with different degrees of renal insufficiency (mild, moderate, severe or patients in dialysis)

compared with patients with normal renal function. This was also shown for patients with overweight (BMI ≥ 27 kg/m² to < 30 kg/m²) or obesity (BMI ≥ 30 kg/m²) and mild to moderate renal insufficiency based on data from phase 3a trials.

Pediatrics

Semaglutide has not been studied in children below 12 years of age. Population modelling analysis was conducted based on pooled datasets from adults (STEP1 4373, N = 1295) and adolescent patients (age 12 to < 18 years) enrolled in STEP TEENS 4451 (N = 124, body weight 61.6-211.9 kg). The model estimated semaglutide exposure (AUC) in adolescents was similar to that in adults.

11 STORAGE, STABILITY AND DISPOSAL

Keep away from the cooling element of the refrigerator. Do not freeze Wegovy[®] and do not use Wegovy[®] if it has been frozen. Protect from excessive heat and light.

Single-Use Pen

Store the Wegovy[®] single-use pen in the refrigerator at 2°C to 8°C. If needed, each single-use pen, prior to cap removal, can be kept at a temperature below 30°C for a total of 28 days.

Storage of the Wegovy[®] single-use pen in the original carton is recommended until time of administration. Safely discard the Wegovy[®] single-use pen after use.

After use: Discard the Wegovy[®] pen in a closable, puncture-resistant sharps container. Do not dispose of the pen in household trash. Do not recycle the filled sharps container.

Multi-Use Pen (FlexTouch[®])

Keep the pen cap on when Wegovy[®] is not in use in order to protect from light.

Before first use: Store in a refrigerator (2°C to 8°C).

After first use: Store below 30°C or in a refrigerator (2°C to 8°C) for up to 8 weeks.

Always remove the injection needle after each injection and store the pen without a needle attached. This may prevent blocked needles, contamination, infection, leakage of solution and inaccurate dosing.

After the final dose of Wegovy[®] the pen should be discarded in accordance with local requirements.

12 SPECIAL HANDLING INSTRUCTIONS

The Wegovy[®] pen is for use by one person only.

Wegovy[®] should not be used if it does not appear clear and colourless, or almost colourless.

Wegovy[®] should not be used if it has been frozen.

Substances added to Wegovy[®] may cause degradation of semaglutide. Wegovy[®] must not be mixed with other medicinal products, e.g. infusion fluids.

Adults

In STEP 1, 2 and 4, all patients received instruction for a reduced calorie diet (approximately 500 kcal/day deficit) and increased physical activity counselling (recommended to a minimum of 150 min/week) that began with the first dose of study medication or placebo and continued throughout the trial. In STEP 3, patients received intensive behavioural therapy (IBT) which was an initial 8-week low-calorie meal plan (total energy intake 1000 to 1200 kcal/day) followed by 60 weeks reduced caloric meal plan (1200-1800 kcal/day) and increased physical activity (100 mins/week with gradual increase to 200 mins/week).

Table 8 Summary of patient demographics for clinical trials in adult patients with either obesity (BMI ≥ 30 kg/m²), or excess weight (BMI ≥ 27 to <30 kg/m²) and at least one weight-related comorbidity

Study #	Trial design	Dosage, route of administration and duration	Study patients (n)	Mean age (Range)	Sex N (%)
STEP 1 - 4373	68-week double blind, placebo controlled ¹	Wegovy [®] 2.4 mg, subcutaneous, once weekly OR Placebo, subcutaneous, once weekly	1961	46 (18 to 86)	Female: 1451 (74%) Male: 510 (26%)
STEP 2 - 4374	68-week double blind, placebo controlled, in patients with Type 2 Diabetes ¹	Wegovy [®] 2.4 mg, subcutaneous, once weekly OR Placebo, subcutaneous, once weekly As an add-on to diet and exercise and up to 3 background diabetes medications (metformin, sulfonylurea [SU], glitazone or sodium-glucose co-transporter 2 inhibitor [SLGT2i])	807	55 (19 to 84)	Female: 412 (51%) Male: 395 (49%)
STEP 3 - 4375	68-week, double blind, placebo controlled, in conjunction with Intensive Behavioural Therapy ¹	Wegovy [®] 2.4 mg, subcutaneous, once weekly OR Placebo, subcutaneous, once weekly	611	46 (18 to 75)	Female: 495 (81%) Male: 116 (19%)

STEP 4 - 4376	68-week double-blind, placebo controlled withdrawal trial	Wegovy® 2.4 mg, subcutaneous, once weekly OR Placebo, subcutaneous, once weekly	902 treated, 803 randomized ²	46 (18 to 78)	Female: 634 (79%) Male: 169 (21%)
------------------	---	---	--	---------------	--

¹Patients randomized to Wegovy® received 52 weeks at target maintenance dose of 2.4 mg

²All treated patients received escalating doses of semaglutide from Weeks 1-16. Patients reaching the 2.4 mg maintenance dose by Week 20 were randomized to continue Wegovy® or switch to placebo at week 20 (baseline)

For STEP 1, STEP 2 and STEP 3, the primary efficacy outcomes were percent change in body weight from baseline to week 68 and percentage of patients who achieve ≥5% body weight reduction. For STEP 4, the primary efficacy outcome was percent change in body weight from baseline to week 68.

STEP 1 – 4373

STEP 1 was a 68-week trial in patients with obesity (BMI ≥30 kg/m²) or overweight (BMI ≥27- <30 kg/m²) with at least one weight-related comorbidity; patients with diabetes were excluded. Patients were randomized in a 2:1 ratio to either Wegovy® or placebo. Patients had a mean age of 46 years (range 18-86), 74.1% were women 75.1% were Caucasian, 13.3% were Asian and 5.7% were Black/African American. A total of 12.0% were Hispanic or Latino. Mean baseline body weight was 105.3 kg (range 61.8-245.6) (232.1lb [range 136.2-541.5]), mean BMI was 37.9 kg/m² (range 26.5-83.0) and 43.7% of patients had pre-diabetes as assessed by investigator. At baseline, weight-related comorbidities in this trial that occurred in more than 10% of patients were dyslipidemia (37.0%), hypertension (36.0%), elevated HbA_{1c} (range 5.7-6.4%) (17.9%), knee or hip osteoarthritis (15.9%), obstructive sleep apnea (11.7%), and asthma/chronic obstructive pulmonary disease (COPD) (11.6%).

STEP 2 – 4374

STEP 2 was a 68-week study in patients with type 2 diabetes and BMI ≥27 kg/m². Patients included in the trial had insufficiently controlled diabetes (HbA_{1c} 7-10%) and were treated with either: diet and exercise alone or in conjunction with 1 to 3 oral antidiabetic drugs (metformin, sulfonylurea [SU], glitazone or sodium-glucose co-transporter 2 inhibitor [SLGT2i]). Patients were randomized in a 1:1 ratio to receive either Wegovy® or placebo. Patients had a mean age of 55 years (range 19-84), 50.9% of patients were women, 62.1% were Caucasian, 26.2% were Asian and 8.3% were Black/African American. A total of 12.8% were Hispanic or Latino. Mean baseline body weight was 99.8 kg (range 54.4-199.2) (220.0 lb [range 119.9-439.2]) and mean BMI was 35.7 kg/m² (range 26.5-66.2). Weight-related comorbidities that occurred in more than 10% of patients were hypertension (69.8%), dyslipidemia (68.0%), liver diseases (22.6%), knee or hip osteoarthritis (19.6%), and obstructive sleep apnea (15.1%). In STEP 2, 78.5% of patients with type 2 diabetes treated with Wegovy® achieved an HbA_{1c} < 7% compared to 26.5% with placebo.

STEP 3 – 4375

STEP 3 was a 68-week trial in patients with obesity (BMI ≥30 kg/m²) or overweight (BMI ≥27- <30 kg/m²) and at least one weight-related comorbid condition; patients with diabetes were excluded. The patients were randomized in a 2:1 ratio to receive either Wegovy® or placebo. Patients had a mean age of 46 years (range 18-75), 81.0% were women, 76.1% were Caucasian, 19.0% were Black/African American and 1.8% were Asian. A total of 19.8% were Hispanic or Latino. Mean baseline body weight was 105.8 kg (range 66.9-216.8) (233.2 lb [range 147.5-478.0]), mean BMI was 38.0 kg/m² (range 27.0-69.0) and 49.8% of patients had pre-diabetes as assessed by investigator. Weight-related comorbidities that occurred in

more than 10% of patients were hypertension (34.7%), dyslipidemia (34.7%), knee and hip osteoarthritis (18.7%), asthma/COPD (15.1%), obstructive sleep apnea (12.6%), menstrual disorders (14.7%), and impaired fasting glucose (10.6%).

All STEP trials met their primary objectives of demonstrating statistically significant weight loss compared to placebo in patients with obesity (BMI ≥ 30 kg/m²) or excess weight (BMI ≥ 27 kg/m² to < 30 kg/m²) and at least one weight-related comorbidity. Treatment benefit was also observed in the secondary endpoints including waist circumference and cardiometabolic parameters. The findings were generally consistent across the 4 clinical trials. See Table 9 for a summary of results at Week 68.

Of note, diet and exercise data were not collected and/or verified for any of the trials. Therefore, the results should be interpreted with caution since the contribution of patient adherence to diet and exercise in the favourable findings with Wegovy[®] is unknown.

Table 9 Changes in Body Weight at Week 68 for STEP 1, 2 and 3

Intention-to-treat ^a	STEP 1		STEP 2		STEP 3	
	Placebo	Wegovy [®]	Placebo	Wegovy [®]	Placebo	Wegovy [®]
Primary outcomes						
Body weight						
Baseline (kg)	105.2	105.4	100.5	99.9	103.7	106.9
% change from baseline	-2.4	-14.9	-3.4	-9.6	-5.7	-16.0
% difference from placebo (LSMean) (95% CI)	-12.4 (-13.4; -11.5)*		-6.2 (-7.3; -5.2)*		-10.3 (-12.0; -8.6)*	
Percent patients losing $\geq 5\%$ body weight						
Week 68 n (%)	31.1	83.5	30.2	67.4	47.8	84.8
% difference from placebo (LSMean) (95% CI)	52.4 (48.1; 56.8)*		37.3 (30.7; 43.8)*		37.0 (28.9; 45.2)*	
Secondary outcomes						
Percent patients losing $\geq 10\%$ body weight						
Week 68 n (%)	12.0	66.1	10.2	44.5	27.1	73.0
% difference from placebo (LSMean) (95% CI)	54.1 (50.4; 57.9)*		34.3 (28.4; 40.2)*		45.9 (38.0; 53.7)*	
Percent patients losing $\geq 15\%$ body weight						
Week 68 n (%)	4.8	47.9	4.3	25.1	13.2	53.5
% difference from placebo (LSMean) (95% CI)	43.1 (39.8; 46.3)*		20.7 (15.7; 25.8)*		40.2 (33.1; 47.3)*	
Change from baseline waist circumference						
Baseline (cm)	114.8	114.6	115.5	114.5	111.8	113.6
Change from baseline (cm)	-4.1	-13.5	-4.5	-9.4	-6.3	-14.6
Difference from placebo (LSMean) (95% CI)	-9.4 (-10.3; -8.5)*		-4.9 (-6.0; -3.8)**		-8.3 (-10.1; -6.6)**	

^aThe intent-to-treat population includes all randomized patients. At week 68, the body weight was missing for 7.2%/11.9% of patients randomized to Wegovy[®]/placebo in STEP 1, for 4.0%/6.7 of patients randomized to Wegovy[®]/placebo in STEP 2 and

for 8.4%/7.4% of patients randomized to Wegovy®/placebo in STEP 3. Missing data were imputed from retrieved subjects of the same randomized treatment arm according to gender, BMI and timing of last available on-treatment measurement of the endpoint.

*p<0.0001 (unadjusted 2-sided) for superiority.

†p<0.005 (unadjusted 2-sided) for superiority.

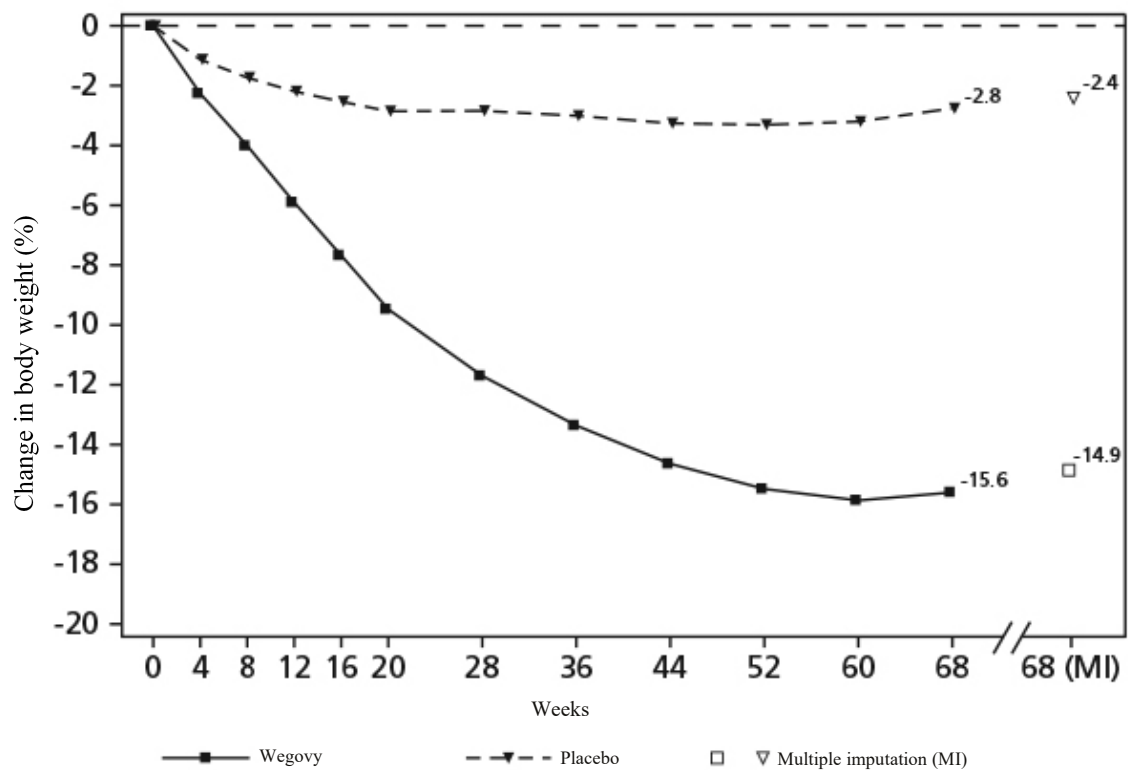

Observed values for patients completing each scheduled visit, and estimates with multiple imputations (MI) from retrieved dropouts

Figure 1 Change from baseline (%) in body weight (STEP 1)

Table 10 Changes in Cardiometabolic Parameters and Glycemic Control at Week 68

Intention-to-treat ^a	STEP 1		STEP 2		STEP 3	
	Placebo	Wegovy	Placebo	Wegovy	Placebo	Wegovy
Systolic blood pressure						
Baseline	127	126	130	130	124	124
Change from baseline (LSMean)	-1.1	-6.2	-0.5	-3.9	-1.6	-5.6
Difference from placebo (LSMean) (95% CI)	-5.1 (-6.3; -3.9)		-3.4 (-5.6; -1.3)		-3.9 (6.4; -1.5)	
Diastolic blood pressure						
Baseline	80	80	80	80	81	80
Change from baseline (LSMean)	-0.4	-2.8	-0.9	-1.6	-0.8	-3.0
Difference from placebo (LSMean) (95% CI)	-2.4 (-3.3; -1.6)		-0.7 (-2.0; 0.6)		-2.2 (-3.9; -0.6)	
HbA_{1c}						
Baseline	5.7	5.7	8.1	8.1	5.8	5.7
Change from baseline (LSMean)	-0.2	-0.5	-0.4	-1.6	-0.3	-0.5
Difference from placebo (LSMean) (95% CI)	-0.3 (-0.3; -0.2)		-1.2 (-1.4; -1.1)		-0.2 (-0.3; -0.2)	
Total cholesterol^b						
Baseline	5.0	4.9	4.4	4.4	4.9	4.7
% change from baseline (LSMean)	0.1	-3.3	-0.5	-1.4	2.1	-3.9
Relative Difference from placebo (LSMean) (95% CI)	-3.3 (-4.8; -1.8)		-0.9 (-3.6; 2.0)		-5.9 (-8.5; -3.2)	
LDL cholesterol^b						
Baseline	2.9	2.9	2.3	2.3	6.2	6.0
% change from baseline (LSMean)	1.3	-2.5	0.1	0.5	2.6	-4.7
Relative Difference from placebo (LSMean) (95% CI)	-3.8 (-5.9; -1.5)		0.4 (-4.0; 4.9)		-7.1 (-10.9; -3.2)	
HDL cholesterol^b						
Baseline	1.3	1.3	1.1	1.2	2.8	2.9
% change from baseline (LSMean)	1.4	5.2	4.1	6.9	5.0	6.5
Relative Difference from placebo (LSMean) (95% CI)	3.8 (2.2; 5.4)		2.7 (-0.3; -5.1)		1.5 (-1.8; 4.9)	
Triglycerides^b						
Baseline	1.4	1.4	1.9	1.7	6.2	6.0
% change from baseline (LSMean)	-7.3	-21.9	-9.4	-22	-6.5	-22.5
Relative Difference from placebo (LSMean) (95% CI)	-15.8 (-18.8; -12.7)		-13.9 (-19.0; -8.4)		-17.0 (-22.8; -10.8)	

^aThe intent-to-treat population includes all randomized patients. Missing data were imputed from retrieved subjects of the same randomized treatment arm according to gender, BMI and timing of last available on-treatment measurement of the endpoint.

^bThe baseline value is the geometric mean

CI: Confidence interval

*p<0.005 (unadjusted 2-sided) for superiority

**p<0.0001(unadjusted 2-sided) for superiority

STEP 4 – 4376

STEP 4 was a 68-week trial that enrolled 902 patients with obesity (BMI ≥30 kg/m²) or with excess weight (BMI ≥27-<30 kg/m²) and at least one weight-related comorbid condition; patients with diabetes were excluded. All patients received Wegovy[®] during the run-in period of 20 weeks which included 16 weeks of dose escalation. There were 803 patients who reached the maintenance dose of Wegovy[®] (2.4 mg) and were then randomized in a 2:1 ratio to either continue on Wegovy[®] or receive placebo. Among randomized patients, the

mean age was 46 years (range 18-78), 79% were women, 83.7% were Caucasian, 13% were Black/African American, and 2.4% were Asian. A total of 7.8% were Hispanic or Latino. Mean body weight at the start of the run-in period (week 0) was 107.2 kg (range 63.1-209.2) (236.3 lb [range 139.1-461.2]), mean BMI at week 0 was 38.4 kg/m² (range 27.4 -75.9) and 46.8% of patients had pre-diabetes as assessed by investigator. Weight-related comorbidities that occurred in more than 10% of patients were hypertension (37.1%), dyslipidemia (35.9%), knee or hip osteoarthritis (13.3%), obstructive sleep apnea (11.7%), and asthma/COPD (11.5%).

Patients who had reached the maintenance dose of Wegovy[®] at week 20 (baseline) and continued treatment with Wegovy[®] for an additional 48 weeks continued losing weight (see Table 11 and Figure 2). On the other hand, in patients switching to placebo at week 20 (baseline), body weight increased steadily from week 20 to week 68. However, the observed mean body weight was lower at week 68 than at start of the run-in period (week 0) (see Figure 2).

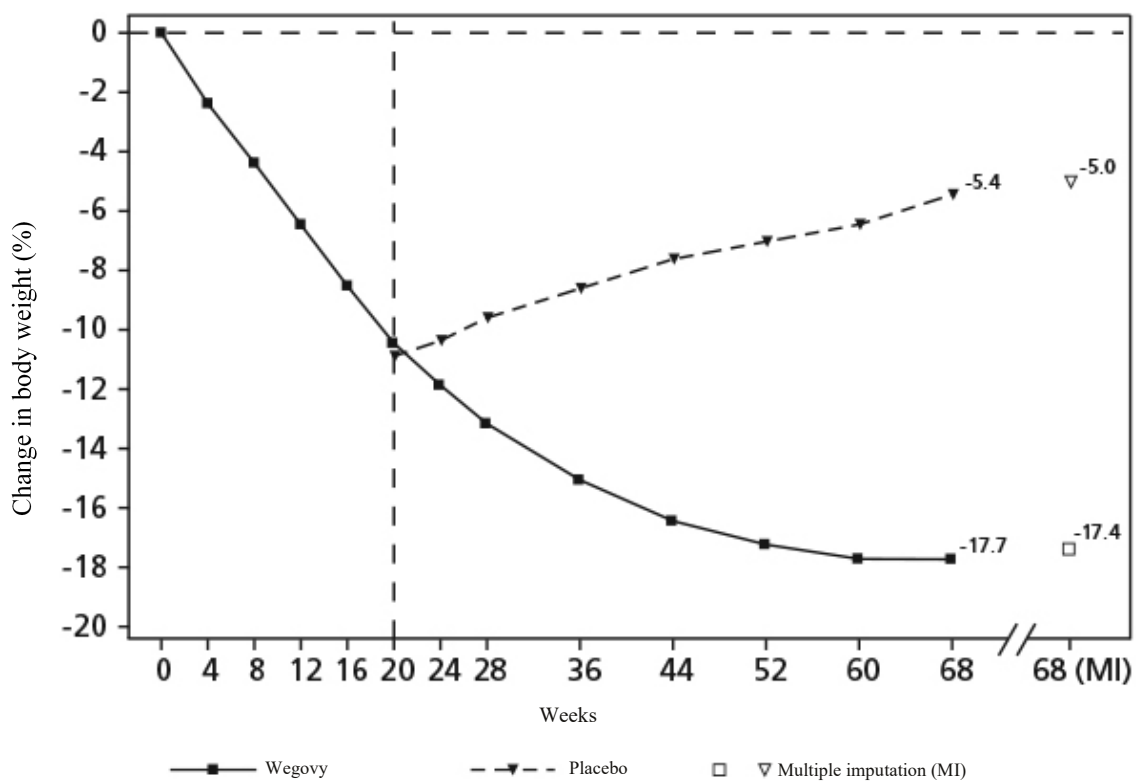

Observed values for patients completing each scheduled visit, and estimates with multiple imputations (MI) from retrieved dropouts

Figure 2 Change from baseline (%) in body weight (STEP 4)

Table 11 Changes in Body Weight at Week 68 -STEP 4 (Obesity or excess weight with comorbidity after 20 week run-in)

	Wegovy [®] N = 803 ^a	
Body Weight (only randomized patients)		
Mean at week 0 (kg)	107.2	
Mean at week 20 (kg)	96.1	
	PLACEBO N = 268	Wegovy [®] N = 535
Body Weight		

Mean at week 20 (SD) (kg)	95.4 (22.7)	96.5 (22.5)
% Change from week 20-68 (LSMean)	6.9	-7.9
% Difference from placebo (LSMean) (95% CI)		-14.8 (-16.0; -13.5)*
Waist Circumference (cm)		
Mean at week 20	104.7	105.5
Change from week 20-68 (LSMean)	3.3	-6.4
Difference from placebo (LSMean) (95% CI)		-9.7 (-10.9; -8.5)*
Systolic Blood Pressure (mmHg)		
Mean at week 20	121	121
Change from week 20-68 (LSMean)	4.4	0.5
Difference from placebo (LSMean) (95% CI)		-3.9 [-5.8; -2.0]*

*The intent-to-treat population includes all randomized patients. At week 68, the body weight was missing for 2.8% and 6.7% of patients randomized to Wegovy® and placebo, respectively. Missing data were imputed from retrieved patients of the same randomized treatment arm.

©©

*p<0.0001 (unadjusted 2-sided) for superiority, controlled for multiplicity.

Patient-Reported Outcomes

Improvement in physical functioning was measured by the general health-related quality of life questionnaire Short Form health survey (SF-36v2) and the obesity-specific Impact of Weight on Quality of Life-Lite for clinical trials Questionnaire (IWQOL-Lite-CT) in STEP 1 and 2. Estimated Treatment Differences were statistically significant in favour of Wegovy® for SF-36 and for IWQOL-Lite-CT. Greater proportions of patients achieved clinically meaningful improvements in physical functioning (defined as proportion of patients achieving an improvement in score of at least 3.7 for SF-36 physical functioning and of at least 14.6 for IWQOL-Lite-CT physical function) with Wegovy® than with placebo for SF-36v2 (39.8% vs. 24.1% in STEP 1 and 41.0% vs. 27.3% in STEP 2) and for IWQOL-Lite-CT (51.8% vs 28.3% in STEP 1 and 39.6% vs. 29.5% in STEP 2).

Effect on Body Composition

In a substudy of 140 patients conducted as part of STEP 1, DEXA analysis showed a 8.4 kg (18.5 lb) reduction in fat mass from a baseline of 42.1 kg (92.8 lb) in Wegovy®-treated patients compared to a 1.4 kg (3.1 lb) reduction from a baseline of 43.3 kg (95.5 lb) in patients treated with placebo. Reductions in lean body mass were 5.3 kg (11.7 lb) and 1.8 kg (4.0 lb) from baseline values of 52.4 kg (115.5 lb) and 51.5 kg (113.5 lb), respectively, for Wegovy® and placebo-treated patients. In patients treated with Wegovy, the fat mass proportion decreased from 43.4% at baseline to 39.4% and the lean body mass proportion increased from 53.9% at baseline to 57.4%. Body composition in the placebo-treated group remained unchanged (total fat mass: 44.6% (baseline), 44.2% (week 68) and lean body mass: 52.7% (baseline), 53.0% (week 68)).

Pediatrics (aged 12 to <18 years)

Wegovy® was evaluated in a 68-week, double-blind, randomized, parallel group, placebo-controlled, multi-center trial in 201 pubertal pediatric patients aged 12 to less than 18 years, with BMI corresponding to ≥95th percentile for age and sex according to the age and sex-specific growth charts (see 1.1 Pediatrics). After a 12-week run-in period of non-pharmacological intervention (including dietary recommendations and physical activity counselling), patients were randomized 2:1 to Wegovy® once-weekly or placebo once-weekly. Wegovy® or matching placebo was escalated to 2.4 mg subcutaneous weekly or maximally tolerated dose during a 16-week period followed by 52 weeks on maintenance

dose. Of Wegovy®-treated patients who completed the trial, 86.7% were on the 2.4 mg dose at the end of the trial.

The mean age was 15.4 years: 37.8% of patients were male, 79.1% were White, 8% were Black or African American and 2% were Asian; 10.9% were of Hispanic or Latino ethnicity. The mean baseline body weight was 107.5 kg, and mean Body Mass Index (BMI) was 37.0 kg/m², and mean BMI Standard Deviation Score (SDS) was +3.31.

The proportions of patients who discontinued study drug were 10.4% for the Wegovy®-treated group and 10.4% for the placebo-treated group; 4.5% of patients treated with Wegovy® and 6% of patients treated with placebo discontinued treatment due to an adverse reaction.

Table 12 Summary of patient demographics for clinical trials in adolescent patients with obesity (BMI ≥95th percentile for age and sex)

Study #	Trial design	Dosage, route of administration and duration	Study patients (n)	Mean age (range)	Sex n (%)
STEP Teens – 4451	68-week double-blind, placebo controlled	Wegovy® 2.4 mg, subcutaneous, once weekly OR Placebo, subcutaneous, once weekly	201	15.4 (12 to 18)	Female: 125 (62.2%) Male: 76 (37.8%)

The primary endpoint in the STEP Teens study in adolescent patients with obesity was percent change in BMI from baseline to week 68. After 68 weeks, treatment with Wegovy® resulted in a statistically significant reduction in percent BMI compared with placebo. Greater proportions of patients treated with Wegovy® achieved ≥5% weight loss than those treated with placebo as shown in Table 13.

Table 13 Changes in Weight and BMI at Week 68 for in Pediatric Patients Aged 12 to less than 18 years

Intention-to-Treat ^a	PLACEBO N = 67	Wegovy® N = 134
BMI		
Baseline BMI	35.7	37.7
% change from baseline in BMI (LSMean ¹)	0.6	-16.1
% difference from placebo (LSMean)		-16.7 (-20.3; -13.2)*
% of Patients losing greater than or equal to 5% body weight	16.3	73.2
% difference from placebo (LSMean) (95% CI)		56.9 (44.6; 69.1)*
% of Patients losing greater than or equal to 10% body weight	6.8	62.8
% of Patients losing greater than or equal to 15% body weight	4.3	53.2
% of Patients losing greater than or equal to 20% body weight	2.8	36.6
Body Weight		
Baseline mean (kg)	102.6	109.9
% change from baseline (LSMean ¹)	2.7	-14.7

LSMean = least squares mean; CI = confidence interval

^aThe intent-to-treat population includes all randomized patients, including 1 Wegovy[®] patient that was randomized but never treated. At week 68, BMI and body weight was missing for 2.2% and 7.5% of patients randomized to Wegovy and placebo, respectively. Missing data were imputed using available data according to value and timing of last available observation on treatment and endpoint's baseline value from retrieved subjects (RD-MI).

¹Model based estimates based on an analysis of covariance model including treatment and stratification groups (gender, Tanner stage group) and the interaction between stratification groups as factors and baseline value as a covariate.

^{*}p<0.0001 (unadjusted 2-sided) for superiority.

The time course of change in BMI with Wegovy[®] and placebo from baseline through week 68 is depicted in Figure 3.

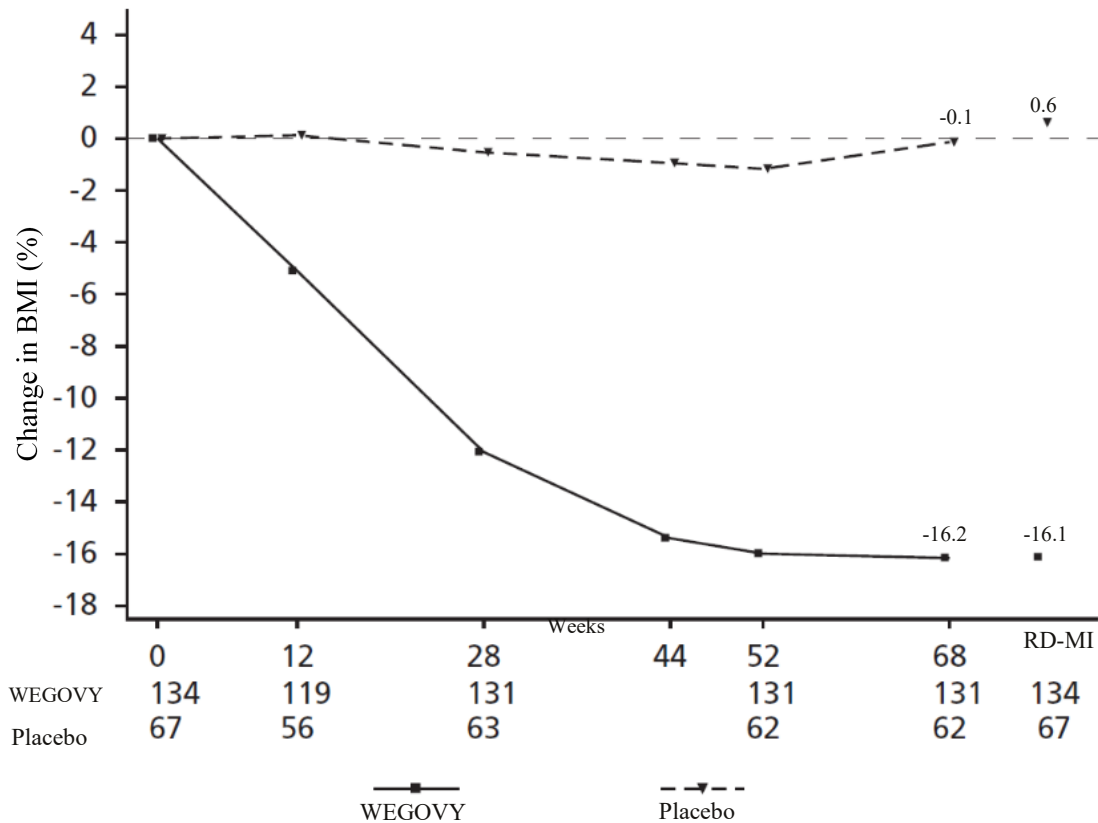

Figure 3 Change from baseline (%) in BMI in Pediatric Patients Aged 12 to less than 18 Years

Changes in waist circumference and cardiometabolic parameters with Wegovy[®] are shown in Table 14 for the study in pediatric patients aged 12 to less than 18 years.

Table 14 Mean Changes in Anthropometry and Cardiometabolic Parameters in Pediatric Patients Aged 12 to Less than 18 Years

	PLACEBO N = 67		WEGOVIY N = 134		Difference from placebo (LSMean)
	Baseline	Change from Baseline (LSMean ¹)	Baseline	Change from Baseline (LSMean ¹)	
Waist Circumferenc e (cm)	107.3	-0.6	111.9	-12.7	-12.1
Systolic Blood Pressure (mmHg)	120	-0.8	120	-2.7	-1.9
Diastolic	73	-0.8	73	-1.4	-0.6

Blood Pressure (mmHg)					
Heart Rate ²	76	-2.3	79	1.2	3.5
HbA1c (%) [*]	5.4	-0.1	5.5	-0.4	-0.2
FPG (mmol/L) [*]	5.0	-0.02	5.0	-0.2	-0.2
	Baseline	% Change from Baseline (LSMean¹)	Baseline	% Change from Baseline (LSMean¹)	Relative difference from placebo (LSMean)
ALT (U/L)	20	-4.9	23	-18.3	-14.1
Total Cholesterol (mg/dL) ^{**}	160.1	-1.3	159.4	-8.3	-7.1
LDL Cholesterol (mg/dL) ^{**}	91.7	-3.6	89.8	-9.9	-6.6
HDL Cholesterol (mg/dL) ^{**}	43.3	3.2	43.7	8.0	4.7
Triglycerides (mg/dL) ^{**}	108.0	2.6	111.3	-28.4	-30.2

Missing data were imputed using available data according to value and timing of last available observation on treatment and endpoint's baseline value from retrieved subjects (RD-MI).

¹Model based estimates based on an analysis of covariance model including treatment and stratification groups (gender, Tanner stage group) and the interaction between stratification groups as factors and baseline value as a covariate.

²Model based estimates based on a mixed model for repeated measures including treatment as a factor and baseline value as a covariate all nested within visit

*For patients without type 2 diabetes at randomization (N=129 for WEGOVY-treated patients and N=64 for placebo-treated patients)

**Baseline value is the geometric mean

STEP Teens included 5 Wegovy[®] treated and 3 placebo treated patients with pre-existing type 2 diabetes. Sample size was inadequate to draw conclusions but there was no apparent difference in clinical efficacy profile for diabetic patients compared to the population at large. Data presented in the above tables includes the patients with type 2 diabetes with the exception of glycemic parameters in Table 14.

14.3 Immunogenicity

Consistent with the potentially immunogenic properties of protein and peptide pharmaceuticals, patients treated with Wegovy[®] may develop anti-drug antibodies (ADAs) to the active ingredient in Wegovy[®] (i.e. semaglutide). The detection of antibody formation is highly dependent on the sensitivity and specificity of the assay. Additionally, the observed incidence of antibody (including neutralizing antibody) positivity in an assay may be influenced by several factors including assay methodology, sample handling, timing of sample collection, concomitant medications, and underlying disease. For these reasons, the incidence of antibodies to semaglutide in the studies described above cannot be directly compared with the incidence of antibodies in other studies or to other products.

Across the adult clinical trials with antibody assessments, 50 (2.9%) Wegovy[®]-treated patients developed ADAs to semaglutide. Of these, 28 patients (1.6%) developed antibodies cross-reacting with native GLP-1. The presence of semaglutide ADAs did not impact the safety or efficacy of Wegovy[®]. The in vitro neutralizing activity of antibodies to semaglutide is uncertain at this time.

15 MICROBIOLOGY

No microbiological information is required for this drug product.

16 NON-CLINICAL TOXICOLOGY

Safety Pharmacology

Acute effects of semaglutide on vital organ function (central nervous system, cardiovascular system and respiration) and renal function were evaluated following subcutaneous dosing in rats or telemetered conscious unrestrained cynomolgus monkeys. Semaglutide was generally well tolerated, but displayed pharmacologically-mediated effects of abnormal gait (walking on toes), decreased touch response, passivity, dirty muzzle, lethargy, piloerection, and increased acute transient diuresis in the rat, at doses below the human C_{max} exposure at the maximal recommended human dose (MRHD) of 2.4 mg/week. In the monkey, no adverse effects were identified on acute cardiovascular function, at doses up to 4-fold the C_{max} exposure at the MRHD. In vitro investigations (hERG ion channel assay and isolated rabbit Purkinje fibres) indicated no effects on cardiac repolarisation.

General Toxicology

Repeat dose toxicity studies were conducted in mice, rats and monkeys. Generally, decreased food consumption was observed in all studies and was accompanied by reduced body weight gain and body weights. Secondary to these effects, non-adverse clinical pathology and organ weight changes were observed across species. Clinical signs of decreased activity, hunched posture, and piloerection were also observed, during the first few weeks of dosing at the highest doses.

In a 13-week repeat-dose toxicity study, mice were dosed subcutaneously with 1, 3 and 10 mg/kg/day (6, 21 and 65-fold the human AUC exposure at the MRHD, based on animal AUC_{24h} values of 11400, 38400, 116500 h*nmol/L). Thyroid C-cell hyperplasia was observed at all dose levels and consequently, a NOAEL could not be identified for this study.

In a 26-week repeat-dose toxicity study, rats were dosed subcutaneously with 0.03, 0.13, and 0.6 mg/kg/day (0.5, 2 and 10-fold the human AUC exposure at the MRHD, based on animal AUC_{24h} values of 902, 3860, 18100 h*nmol/L). In the absence of any adverse findings, the NOAEL was determined to be 0.6 mg/kg/day.

In a 52-week repeat-dose toxicity study, cynomolgus monkeys were dosed subcutaneously with 0.01, 0.06, and 0.36 mg/kg/twice-weekly (0.3, 2 and 10-fold the human AUC exposure at the MRHD, based on animal AUC_{72h} values of 1460, 9240, 54700 h*nmol/L). Electrocardiography (ECG) recordings revealed a continuous left-bundle-branch-block ECG recording in Weeks 26 and 52 in one high-dose female. In addition, histopathology revealed multifocal myocardial vacuolation, with karyomegaly, in the left ventricle of one high-dose male. As it could not be excluded that these findings were treatment related, 0.06 mg/kg twice-weekly was determined to be the NOAEL.

Carcinogenicity

Non-lethal thyroid C-cell tumours observed in rodents are a class effect for GLP-1 receptor agonists. In a 2-year carcinogenicity study in CD-1 mice, subcutaneous doses of 0.3, 1 and 3 mg/kg/day (2, 6 and 22-fold the human AUC exposure, at the MRHD, based on animal AUC_{24h} values of 3090, 11400, 39500 h*nmol/L) was administered to the males, and 0.1, 0.3 and 1 mg/kg/day (0.6, 2 and 6-fold the human AUC exposure at the MRHD, based on animal AUC_{24h} values of 1110, 3090, 11400 h*nmol/L) was administered to the females. High incidence rates of focal/multifocal C-cell hyperplasia and C-cell adenoma were observed in both sexes at all doses. In control animals, the incidence rate of C-cell hyperplasia was very low and no incidences of C-cell adenoma were observed. The increase in thyroid C-cell

adenomas was statistically significant in both sexes at all doses. A numerical increase in C-cell carcinomas was observed in males and females at all doses, while no incidences of C-cell carcinomas were observed in control animals. A NOAEL could not be identified for this study.

In a 2-year carcinogenicity study in Sprague Dawley rats, subcutaneous doses of 0.0025, 0.01, 0.025 and 0.1 mg/kg/day were administered (below quantification, 0.2, 0.4 and 2-fold the human AUC exposure at the MRHD, based on animal AUC_{24h} values of below qualification, 293, 641, 3820 h*nmol/L). An increase in incidence of focal C-cell hyperplasia of the thyroid was observed in males at all doses. A statistically significant increase in thyroid C-cell adenomas was observed in males and females at all doses, and a statistically significant increase in thyroid C-cell carcinomas was observed in males at ≥ 0.01 mg/kg/day, and in females at 0.1 mg/kg/day. The increases in the incidences of thyroid C-cell adenomas and carcinomas were largely dose-dependent. A NOAEL could not be identified for this study.

In both studies, the increased incidences of thyroid C-cell hyperplasia, adenoma, and carcinoma were determined to be treatment-related. Thyroid C-cell tumours are rare findings during carcinogenicity testing in mice and rats. The human relevance of thyroid C-cell tumours in these rodent species is unknown and could not be determined based on the results of the clinical or nonclinical studies (see [7 WARNINGS AND PRECAUTIONS, Carcinogenesis and Mutagenesis](#)).

No other treatment-related tumours were observed in the carcinogenicity studies.

Genotoxicity

Semaglutide was not mutagenic or clastogenic in a standard battery of genotoxicity tests (bacterial reverse mutation test, in vitro chromosomal aberration test in human peripheral blood lymphocytes, and in vivo rat bone marrow micronucleus test).

Reproductive and Developmental Toxicity

In a combined fertility and embryo-fetal developmental toxicity study in rats, subcutaneous doses of 0.01, 0.03 and 0.09 mg/kg/day (0.04, 0.1 and 0.4-fold the human AUC exposure at the MRHD, based on animal AUC_{24h} values of 82.9, 247, 735 h*nmol/L) were administered to male and female rats. Males were dosed for 4 weeks prior to mating, and females were dosed for 2 weeks prior to mating and throughout organogenesis until Gestation Day (GD) 17. No effects were observed on mating performance or male fertility. In females, an increase in estrus cycle length was observed at all dose levels, together with a small reduction in numbers of corpora lutea (ovulations) at ≥ 0.03 mg/kg/day. Semaglutide caused embryotoxicity below clinically relevant exposures. Semaglutide caused reductions in maternal body weight, and reduction in number of corpora lutea, leading to fewer implantations and reduced fetal growth. In fetuses, increased incidences of skeletal and visceral malformations were observed at the mid and high dose, consisting of short tibia/malrotated hindlimb at the high dose and retro-oesophageal aortic arch (cardiovascular malformation) in combination with variation in the origin of the right subclavian artery observed at the two highest doses. Increased incidences of minor abnormalities were also observed at the high-dose, including skeletal variations (partially fused, misaligned, or reduced ossification of skeletal components) and dilated lateral brain ventricles. Thus, the NOAEL for the embryo-fetal toxicity of semaglutide in rats was determined to be 0.01 mg/kg/day.

In an embryo-fetal developmental toxicity study in rabbits, subcutaneous doses of 0.001, 0.0025 and 0.0075 mg/kg/day (0.01, 0.1 and 0.9-fold the human AUC exposure at the MRHD, based on animal AUC_{24h} values of 20.2, 208, 1530 h*nmol/L) were administered to female rabbits throughout organogenesis i.e. from GD6 to GD19. Semaglutide markedly

reduced maternal body weight gain and food and water consumption. Semaglutide caused increased post-implantation losses and an increased incidence of incomplete ossification of metacarpals (skeletal variation) at the mid and the high dose, and increased incidences of other minor, non-adverse skeletal abnormalities at all dose levels. There was also an increased incidence of minor visceral abnormalities, consisting of dilated renal pelvis at the high dose, and increased incidences of forelimb/paw flexure at the mid and high doses. An increased number of visceral malformations were also observed at the mid and high dose that were not observed in controls, and consisted of multiple folded retina: absent vitreous humour, misshapen heart: dilated pulmonary trunk, absent kidney/ureter, absent adrenals, and bent scapula: hyperextension of the forelimb. Thus, the NOAEL for the embryo-fetal toxicity of semaglutide in rabbits was determined to be 0.001 mg/kg/day.

In an embryo-fetal developmental toxicity study in cynomolgus monkeys, subcutaneous doses of 0.015, 0.075, and 0.15mg/kg (0.4, 2 and 6-fold the human AUC exposure at the MRHD, based on animal AUC_{72h} values of 2000, 10400, 30000 h*nmol/L) were administered to pregnant monkeys from GD 20 to 50 every 3 days. Marked maternal body weight loss and reduced food consumption was observed at all doses during the dosing period. A slightly increased incidence of fetal malformations was observed at the mid- and high-dose. The fetal abnormalities included skeletal abnormalities, consisting of shifts in the alignment of the vertebrae, ribs, and sternbrae at the cervico-thoracic border observed in one fetus of each of the mid- and high-dose groups, a misshapen right brain hemisphere, which was due to accumulation of blood between the dura mater and the brain, in a high-dose fetus, fused kidneys in a mid-dose fetus, and liver cysts in another mid-dose fetus. Thus, the NOAEL for the embryo-fetal toxicity of semaglutide in cynomolgus monkeys was determined to be 0.015 mg/kg administered every 3 days.

In a combined embryo-fetal and pre- and post-natal developmental toxicity study in cynomolgus monkeys, subcutaneous doses of 0.015, 0.075, and 0.15mg/kg (0.2, 1 and 3-fold the human AUC exposure at the MRHD, based on animal AUC_{72h} values of 1320, 6720, 14400 h*nmol/L) were administered to pregnant monkeys from GD 20 to 140 every 3 days. A higher incidence of pre-natal loss was observed in the mid- and high-dose groups. The incidence of pre-natal loss was 5/24 (21%), 5/22 (23%), 7/22 (32%), and 10/24 (42%) in the control, low-, mid-, and high-dose groups, respectively, with the most losses occurring between GD 20 and 50; early pre-natal loss was 2/24 (8.3%), 1/22 (4.5%), 5/22 (23%), and 8/24 (33%) in the control, low-, mid-, and high-dose groups, respectively. A higher incidence of post-natal loss was also observed at all doses. The incidence of post-natal loss was 0/19 (0%), 5/17(29%), 3/15(20%), and 3/14(21%) in the control, low-, mid-, and high-dose groups, respectively. Infants were also slightly smaller at delivery in the two highest dose groups, but recovered during the lactation period. The NOAEL for the developmental toxicity of semaglutide in cynomolgus monkeys was determined to be 0.015 mg/kg administered every 3 days.

Juvenile Toxicity

In a juvenile toxicity study in rats, subcutaneous doses of 0.02, 0.13 and 0.6 mg/kg/day (0.3, 2 and 8-fold the human pediatric AUC exposure at the MRHD, based on animal AUC_{24h} values of 456, 3610, 15000 h*nmol/L) were administered to young rats from Postnatal Day 21 to 98. As in other studies, lower body weight gain, body weights, and food consumption were observed in animals administered semaglutide when compared to control animals. Semaglutide also caused a delay in sexual maturation in both males and females. There were no consequential effects on estrus cycle length, the reproductive organs of either sex, the reproductive capacity of either sex, or on the ability of the females to maintain pregnancy.

READ THIS FOR SAFE AND EFFECTIVE USE OF YOUR MEDICINE

PATIENT MEDICATION INFORMATION

PrWegovy® semaglutide injection

Read this carefully before you start taking **Wegovy®** and each time you get a refill. This leaflet is a summary and will not tell you everything about this drug. Talk to your healthcare professional about your medical condition and treatment and ask if there is any new information about **Wegovy®**.

Serious Warnings and Precautions Possible Risk of thyroid tumours, including cancer

As part of drug testing, semaglutide, the active ingredient in Wegovy® was given to rats and mice in long term studies. In these studies, semaglutide caused both rats and mice to develop medullary thyroid tumours, some of which were cancer. It is not known if semaglutide will cause thyroid tumours or a rare type of thyroid cancer called medullary thyroid cancer in people. Do not use Wegovy® if you or any of your family have ever had a type of thyroid cancer called medullary thyroid carcinoma (MTC), or if you have an endocrine system condition called Multiple Endocrine Neoplasia syndrome type 2 (MEN 2).

While taking Wegovy®, tell your doctor if you get a lump or swelling in your neck, hoarseness, trouble swallowing or shortness of breath. These may be symptoms of thyroid cancer. You should discuss any safety concerns you have about the use of Wegovy® with your doctor.

What is Wegovy® used for?

Wegovy® is used for chronic weight management in addition to reduced calorie diet and increased physical activity in adults, who have:

- a BMI of 30 kg/m² or greater (with obesity), or
- a BMI of 27 kg/m² and less than 30 kg/m² (overweight) and weight-related health problems.

**BMI (Body Mass Index) is a measure of your weight in relation to your height. See your doctor to have your BMI measured.*

Wegovy® is used for chronic weight management in addition to a reduced calorie diet and increased physical activity in adolescents aged 12 to less than 18 years, who have obesity, as diagnosed by a doctor, and who have not succeeded in weight loss with diet and exercise alone.

How does Wegovy® work?

Wegovy® is similar to a natural hormone called glucagon-like peptide-1 (GLP-1) that is released from the intestine after a meal. Wegovy® works by causing you to feel fuller and less hungry. Wegovy® should be used along with a reduced calorie diet and increased physical activity.

What are the ingredients in Wegovy®?

Medicinal ingredients: semaglutide

Single-Use Pen

Non-medicinal ingredients: Disodium phosphate dihydrate; Hydrochloric acid; Sodium Chloride; Sodium hydroxide; Water for injection

Multi-Use pen

Non-medicinal ingredients: Disodium phosphate dihydrate; Propylene glycol; Phenol; Hydrochloric acid; Sodium hydroxide; Water for injection

Wegovy® comes in the following dosage forms:

Wegovy® is supplied as a clear and colourless solution for injection in a pre-filled pen.

Wegovy® is available in a carton of 4 single-use, disposable, pre-filled pens delivering doses of either 0.25 mg, 0.5 mg, 1 mg, 1.7 mg, or 2.4 mg. The 0.25 mg, 0.5 mg and 1 mg pens contain 0.5 mL solution. The 1.7 mg and 2.4 mg pens contain 0.75 mL of solution.

Wegovy® is available in a carton of 1 multi-use, disposable, pre-filled pen delivering doses of either 0.25 mg, 0.5 mg, 1 mg, 1.7 mg, or 2.4 mg. The 0.25 mg and 0.5 mg pens contain 1.5 mL solution. The 1 mg, 1.7 mg and 2.4 mg pens contain 3 mL of solution.

Your single-use pen is only to be used once. It comes with:

- **One pre-set dose.**
- **A needle cover** that hides the built-in needle before, during and after use.
- **Automatic dosing** that starts when the needle cover is pressed against your skin as described by your healthcare professional.
-

Your multi-use pen can be used multiple times. It comes with:

- **Four doses of either 0.25 mg, 0.5 mg, 1 mg, 1.7 mg or 2.4 mg.**
- **4 disposable needles**

Do not use Wegovy® if:

- You are allergic to semaglutide or any of the other ingredients of this medicine.
- You or a member of your family has ever had medullary thyroid cancer (MTC).
- You have Multiple Endocrine Neoplasia syndrome type 2 (MEN 2).
- You are pregnant or breastfeeding.

To help avoid side effects and ensure proper use, talk to your healthcare professional before you take Wegovy®. Talk about any health conditions or problems you may have, including if you:

- or a member of your family has or has had medullary thyroid carcinoma (MTC), or if you have Multiple Endocrine Neoplasia syndrome type 2 (MEN 2).
- Have type 1 diabetes.
- Have ever had diabetic ketoacidosis (increased ketones in the blood or urine).
- Have ever had an allergic reaction to OZEMPIC® or RYBELSUS®.
- Have a high heart rate (fast pulse).
- Have ever had an inflamed pancreas (pancreatitis).
- Are breastfeeding or plan to breastfeed.
- Are pregnant or plan to become pregnant.
- Have end stage renal disease.
- Have gastrointestinal (digestive) problems, including severe vomiting, diarrhea and/or dehydration.

- Have hepatic (liver) disease.
- Have diabetic eye disease (diabetic retinopathy).
- Have heart failure.
- Have ever had gallbladder disease.
- Have ever attempted suicide, or had suicidal thoughts or depression.

Other warnings you should know about:

Children and adolescents

Wegovy® is not recommended in children and adolescents under 12 years of age or less than 60 kg (132 lbs) as the safety and efficacy in this age and weight group have not yet been studied.

Pregnancy and breastfeeding

Tell your doctor if you are pregnant, think you might be pregnant, or are planning to become pregnant. Wegovy® should not be used during pregnancy and for at least two months before a planned pregnancy because it is not known if it may affect your unborn child.

If you could become pregnant while using Wegovy®, it is recommended to use contraception.

Do not use this medicine if you are breast-feeding. This is because it is not known if Wegovy® passes into breast milk.

Driving and using machines

If you use this medicine in combination with certain diabetes medications (e.g. sulfonylurea or insulin), low blood sugar may occur which may reduce your ability to concentrate or make you feel dizzy. Avoid driving or using machines if you feel dizzy or unable to concentrate. Talk to your doctor for further information.

Severe and on-going stomach pain which could be due to inflammation of the pancreas

If you have severe and on-going pain in the stomach area – see a doctor straight away as this could be a sign of acute pancreatitis (inflamed pancreas).

Effects on the digestive system and dehydration

During treatment with Wegovy®, you may experience feeling sick (nausea) or being sick (vomiting), and diarrhea. These side effects can cause dehydration (loss of fluids). It is therefore important to drink plenty of fluids to prevent dehydration. This is especially important if you have kidney problems. Talk to your doctor if you have any questions or concerns.

Diabetic eye disease (retinopathy)

This medication may cause a temporary worsening of diabetic eye disease. If you have diabetic eye disease and experience eye or vision problems while taking this medication, talk to your doctor.

Low blood sugar (hypoglycemia)

If you are taking certain diabetes medication (e.g. sulfonylurea or insulin) when you start taking Wegovy®, this could result in low blood sugar levels. Your doctor may ask you to test your blood sugar levels. This will help your doctor decide if the dose of your diabetes medication needs to be changed.

Tell your healthcare professional about all the medicines you take, including any drugs,

vitamins, minerals, natural supplements or alternative medicines.

People with Diabetes

In particular, tell your doctor, pharmacist or nurse if you are using medicines containing any of the following:

- sulfonylurea
- insulin

Do not use Wegovy® as a substitute for insulin.

The following may interact with Wegovy®:

The following list includes some, but not all, of the drugs that may increase your heart rate. You should check with your doctor or pharmacist before taking any other medication with Wegovy®:

- Drugs to treat hypertension.
- Drugs to treat heart failure.
- Drugs to treat HIV infection.
- Drugs to treat attention deficit-hyperactivity disorder.
- Drugs to suppress appetite/cause weight loss.
- Decongestants.
- Drugs to treat asthma.

How to take Wegovy®

Wegovy® is given as an injection under the skin (subcutaneous injection). Do not inject it into a vein or muscle. The best places to give the injection are the front of your thighs, the front of your waist (abdomen), or your upper arm.

Before you use the pen for the first time, your healthcare professional will show you how to use it.

Detailed instructions for use are on the other side of this leaflet.

Always use this medicine exactly as your doctor has told you. Check with your doctor, pharmacist or nurse if you are not sure.

You should use Wegovy® once a week on the same day each week if possible. You can give yourself the injection at any time of the day – regardless of meals. To help you remember to inject Wegovy® once a week only, it is recommended to note the chosen day of the week (e.g. Wednesday) on the carton.

If necessary, you can change the day of your weekly injection of Wegovy® as long as it has been at least 3 days since your last injection of Wegovy®.

Your doctor should start you on a reduced calorie meal plan and physical activity program when you start taking Wegovy®. Stay on this program while you are taking Wegovy®.

Usual dose:

Adults

The recommended dose is 2.4 mg once weekly.

Your treatment will start at a low dose which will be gradually increased over 16 weeks of treatment.

- When you first start taking Wegovy[®], the starting dose is 0.25 mg once weekly
- Your doctor will instruct you to gradually increase your dose every 4 weeks until you reach the recommended dose of 2.4 mg once weekly.

You will be told to follow the table below.

Dose escalation	Weekly Dose
Week 1 – 4	0.25 mg
Week 5 – 8	0.5 mg
Week 9 – 12	1 mg
Week 13 – 16	1.7 mg
Maintenance Dose	2.4 mg

- Once you reach the recommended dose 2.4 mg, keep using this dose. Do not increase your dose further.

Your doctor will assess your treatment on a regular basis and may tell you to change your dose if necessary.

Do not stop using this medicine without talking to your doctor.

Adolescents

For adolescents aged 12 to less than 18 years, the same dose escalation schedule as for adults should be applied (see above). Adolescents should aim at reaching the 2.4 mg maintenance dose, but can stay at a lower dose if the 2.4 mg dose cannot be reached or is not tolerated.

Overdose:

If you use more Wegovy[®] than you should, talk to your doctor straight away. You may get side effects such as feeling sick (nausea) or being sick (vomiting), or diarrhea, or hypoglycemia (dizziness, confusion, passing out).

If you think you have taken too much Wegovy[®], contact your healthcare professional, hospital emergency department or regional poison control centre immediately, even if there are no symptoms.

Missed Dose:

If you forgot to inject a dose and:

- It is 5 days or less since you should have used Wegovy[®], use it as soon as you remember. Then inject your next dose as usual on your scheduled day.
- It is more than 5 days since you should have used Wegovy[®], skip the missed dose. Then inject your next dose as usual on your scheduled day.

Do not take a double dose to make up for a missed dose.

What are possible side effects from using Wegovy[®]?

These are not all the possible side effects you may feel when taking Wegovy[®]. If you experience any side effects not listed here, contact your healthcare professional.

Like all medicines, this medicine can cause side effects, although not everybody gets them.

Very common: may affect more than 1 in 10 people

- feeling or being sick (nausea or vomiting)
- diarrhea
- constipation
- stomach pain
- feeling weak or tired
- headache
- these usually goes away over time

Common: may affect up to 1 in 10 people

- feeling dizzy
- upset stomach or indigestion
- burping
- gas (flatulence)
- bloating of the stomach
- inflamed stomach ('gastritis') – the signs include stomach-ache, feeling sick (nausea) or being sick (vomiting)
- reflux or heartburn – also called 'gastro-esophageal reflux disease'
- hair loss
- injection site reactions
- low blood sugar (hypoglycaemia) in patients with diabetes
- low blood pressure
- increase of pancreatic enzymes (such as lipase) shown in blood tests
- hemorrhoids
- change in the way food or drink tastes

The warning signs of low blood sugar may come on suddenly. They can include: cold sweat, cool pale skin, headache, fast heartbeat, feeling sick (nausea) or very hungry, changes in vision, feeling sleepy or weak, feeling nervous, anxious or confused, difficulty concentrating or shaking.

Your doctor will tell you how to treat low blood sugar and what to do if you notice these warning signs.

Low blood sugar is more likely to happen if you also take a sulfonylurea or insulin. Your doctor may reduce your dose of these medicines before you start using this medicine.

Uncommon: may affect up to 1 in 100 people

- fast heartbeat
- increase of pancreatic enzymes (such as amylase) shown in blood tests
- feeling faint or fainting/passing out
- low blood sugar (hypoglycemia) in patients without diabetes

Unknown:

- ileus (a severe form of constipation with additional symptoms such as stomach ache, bloating, vomiting etc)
- bowel obstruction
- a delay in the emptying of the stomach

Serious side effects and what to do about them			
Symptom / effect	Talk to your healthcare professional		Stop taking drug and get immediate medical help
	Only if severe	In all cases	
COMMON Patients with Type 2 Diabetes – Diabetic retinopathy complications – complications of diabetic eye disease/diabetic eye problems		√	
Gallstones Symptoms: sudden pain in the upper stomach or back, often on the right, nausea, vomiting, indigestion, or cramping		√	√
UNCOMMON Pancreatitis (severe and ongoing pain in the stomach area which could be a sign of inflamed pancreas)		√	√
Patients with Type 2 Diabetes – Severe hypoglycemia (low blood sugar) symptoms: feeling confused, fits and passing out		√	
Appendicitis Symptoms: sudden pain in the middle or lower right side of the abdomen, chills, fever, nausea, vomiting		√	√
Acute kidney injury Symptoms: swelling in the legs, ankles and feet, feeling tired, confusion, shortness of breath, not enough urine		√	√
RARE Severe allergic reaction (anaphylactic reaction, angioedema) symptoms: breathing problems, swelling of face, lips, tongue and/or throat with difficulty swallowing, and a fast heartbeat		√	√

If you have a troublesome symptom or side effect that is not listed here or becomes bad enough to interfere with your daily activities, talk to your healthcare professional.

Reporting Side Effects

You can report any suspected side effects associated with the use of health products to Health Canada by:

- Visiting the Web page on Adverse Reaction Reporting (<https://www.canada.ca/en/health-canada/services/drugs-health-products/medeffect-canada.html>) for information on how to report online, by mail or by fax; or
- Calling toll-free at 1-866-234-2345.

NOTE: Contact your health professional if you need information about how to manage your side effects. The Canada Vigilance Program does not provide medical advice.

Storage:

Keep out of reach and sight of children.

Do not use this medicine after the expiry date which is stated on the pen label and carton after 'EXP'. The expiry date refers to the last day of that month.

Keep away from the cooling element of the refrigerator. Do not freeze Wegovy[®] and do not use Wegovy[®] if it has been frozen. Protect from excessive heat and light.

Wegovy[®] pen is for use by one person only.

Wegovy[®] should not be used if it does not appear clear and colourless.

Do not dispose of any medicines via wastewater or household waste. Ask your pharmacist how to dispose of medicines you no longer use. These measures will help protect the environment.

Single-Use Pen

Store the Wegovy[®] single-use pen in the refrigerator at 2°C to 8°C. If needed, each single-use pen, prior to cap removal, can be kept at a temperature below 30°C for a total of 28 days.

If your pen has been exposed to light or temperatures above 30°C, has been out of the refrigerator for more than 28 days, or has been frozen, dispose of it.

Storage of Wegovy[®] single-use pen in the original carton is recommended until time of administration in order to protect from light.

Safely discard the Wegovy[®] single-use pen into a sharps disposal container after use. Do not dispose of the pen in your household trash.

Multi-Use Pen

When you are not using the pen, keep the pen cap on in order to protect from light.

Before Opening:

Store in a refrigerator (2°C – 8°C).

During Use:

You can keep the pen for 8 weeks when stored at a temperature below 30°C or in a refrigerator (2°C – 8°C).

If your pen has been exposed to temperatures above 30°C, has been out of the refrigerator for

more than 8 weeks, or has been frozen, dispose of it.

Always remove the injection needle after each injection and store the pen without a needle attached. This may prevent blocked needles, contamination, infection, leakage of solution and inaccurate dosing.

If you want more information about Wegovy®:

- Talk to your healthcare professional
- Find the full product monograph that is prepared for healthcare professionals and includes this Patient Medication Information by visiting the Health Canada website (<http://hc-sc.gc.ca/index-eng.php>); the manufacturer's website www.novonordisk.ca, or by calling 1-800-465-4334.

This leaflet was prepared by Novo Nordisk Canada Inc.

Last Revised 2024

Wegovy®, NovoFine®, NovoFine® Plus and Novo Nordisk are trademarks of Novo Nordisk A/S and used under license by Novo Nordisk Canada Inc.

© 2024

Novo Nordisk Canada Inc.

Instructions for Use

Wegovy® multi-use pre-filled pen (FlexTouch®)

Before using your once-weekly Wegovy® pen, **read these instructions carefully**, and talk to your doctor, nurse or pharmacist about how to inject Wegovy® correctly.

Wegovy® pen is a multi-use pen that **contains four of your prescribed doses of Wegovy®**, corresponding to four times of once-weekly use.

Please use the table on the back of the carton to keep track of how many injections you have taken and how many doses remain in your pen.

Wegovy® comes in five different strengths, each containing one of the following prescribed doses of semaglutide:

0.25 mg **0.5 mg** **1 mg** **1.7 mg** **2.4 mg**

Always start by checking your pen label to make sure that it contains your prescribed dose of Wegovy®.

Your pen is designed to be used with NovoFine® Plus or NovoFine® disposable needles up to a length of 8 mm.

The pack contains:

- Wegovy® pen
- 4 disposable needles
- Leaflet

- **Important information**

Read this Instructions for Use before you start using Wegovy®. This information does not replace talking to your healthcare provider about your medical condition or treatment.

- **Only inject one dose of Wegovy® once weekly.** If you do not take your Wegovy® as prescribed, you may not get the intended effect of this medicine.
- If you take more than one type of injectable medicine, it is very **important to check the name and dose** of your pen label **before use**.
- **Do not use this pen without help if you have poor eyesight and cannot follow these instructions.** Get help from a person with good eyesight who is trained to use the Wegovy® pen.
- Always keep pen and needles **out of sight and reach of others, especially children.**
- **Never share** your pen or your needles with other people.
- **Needles are for single use only. Never reuse your needles** as it may lead to blocked needles, contamination, infection and inaccurate dosing.
- Caregivers must **be very careful when handling used needles** to prevent accidental needle injuries and infection.

Wegovy® pen (example)

Please note: Your pen may differ in size from the pen shown in the pictures. These instructions apply to all Wegovy® pens.

Wegovy[®] pen (example)

Please Note: Your pen may differ in size from the pen shown in the pictures.

These instructions apply to all Wegovy[®] pens.

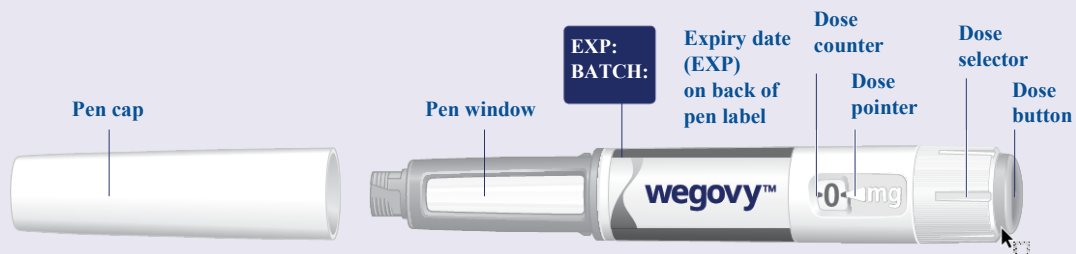

Disposable needle (example)

Disposable needle (example)

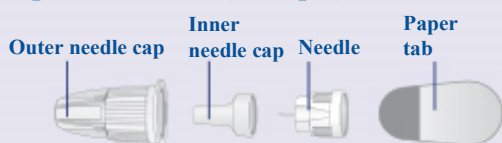

1 Prepare your pen with a new needle

Check the name and dose of your pen to make sure it contains your prescribed dose of Wegovy[®].

Pull off the pen cap.

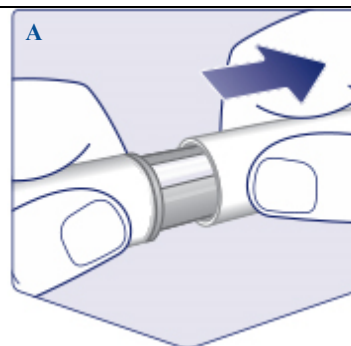

Check that the Wegovy[®] in your pen is clear and colourless. Look through the pen window. If the solution looks cloudy or coloured, do not use the pen.

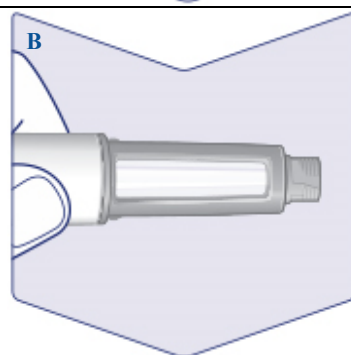

Always use a new needle for each injection.
Take a needle when you are ready to take your injection. Check the paper tab and the outer needle cap for damages. If you see any damage, this could affect sterility. Dispose of it and use a new needle.

Tear off the paper tab.

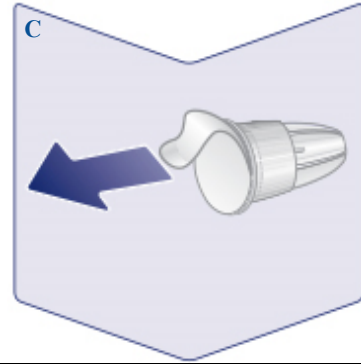

Push the needle straight onto the pen. Turn until it is on tight.

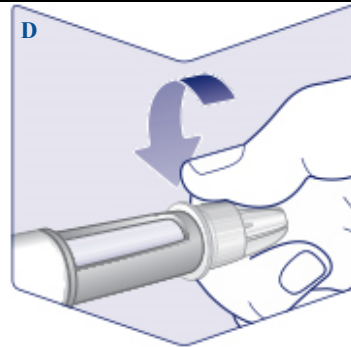

The needle is covered by two caps. You must remove both caps. If you forget to remove both caps you will not inject any medicine.

Pull off the outer needle cap and keep it for later. You will need it to safely remove the needle from the pen after the injection.

Pull off the inner needle cap and dispose of it. A drop of solution may appear at the needle tip. You must still check the flow if you use a new pen for the first time. See '**Check the flow with each new pen**'.

Never use a bent or damaged needle. For more information about needle handling, see '**About your needles**' below these instructions.

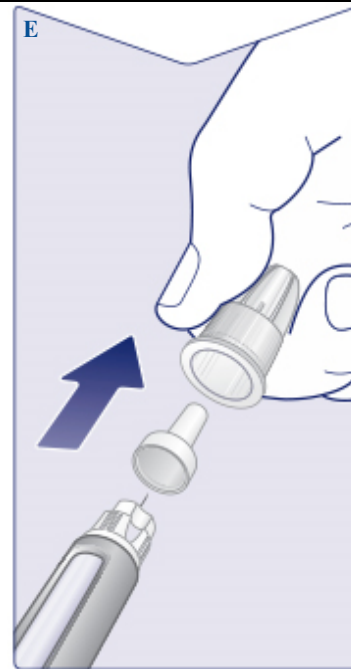

Check the flow with each new pen

If your pen is already in use, go to '**2 Set your dose**'.

Only check the flow before your **first injection with each new pen.**

Turn the dose selector until you see the flow check symbol ().



Make sure the flow check symbol lines up with the dose pointer.



Hold the pen with the needle pointing up.

Press and hold in the dose button until the dose counter returns to **0**. The **0** must line up with the dose pointer.

A drop of solution should appear at the needle tip. This drop indicates that your pen is ready for use.

If a drop does not appear, check the flow again. **This should only be done twice.**

If there is still no drop, **change the needle and check the flow once more. If a drop still does not appear**, dispose of the pen and use a new one.



2 Set your dose

Turn the dose selector until the dose counter stops, and it shows your prescribed dose.



The dashed line () in the dose counter will guide you to your dose.

The dose selector clicks differently when turned forward, backwards or past your dose. You will hear a 'click' every time you turn the dose selector. **Do not set the dose by counting the number of clicks you hear.**

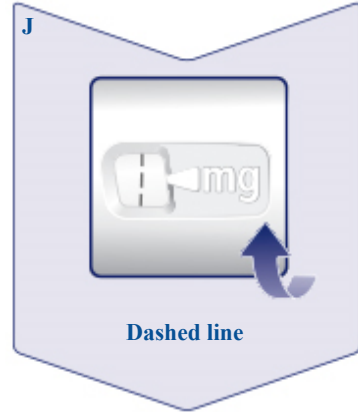

When your prescribed dose lines up with the dose pointer, you have selected your dose. In this picture, the dose **0.25 mg** is shown as an example.

If the dose counter stops before you reach your prescribed dose, see the section '**Do you have enough Wegovy®?**' below these instructions.

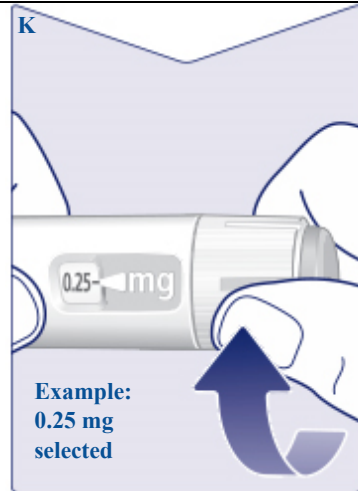

Choose your injection site

Choose upper arms, stomach or upper legs (keep a 5 cm distance from your belly button).

You may inject in the same body area each week, but make sure it is not in the same spot as used the last time.

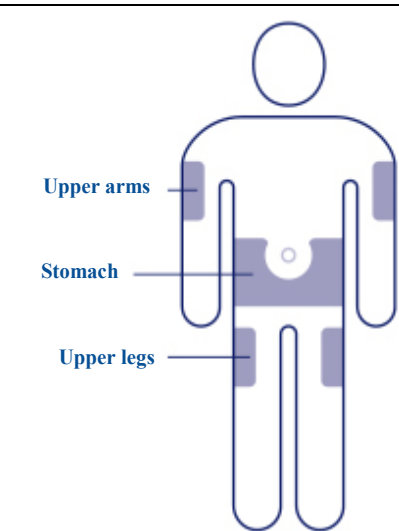

3 Inject your dose

Insert the needle into your skin as your healthcare professional has shown you.

Make sure you can see the dose counter. Do not cover it with your fingers. This could interrupt the injection.



Press and hold down the dose button until the dose counter shows 0.

Keep pressing the dose button with the needle in your skin and slowly count to 6. The 0 must line up with the dose pointer. You may hear or feel a click when the dose counter returns to 0.

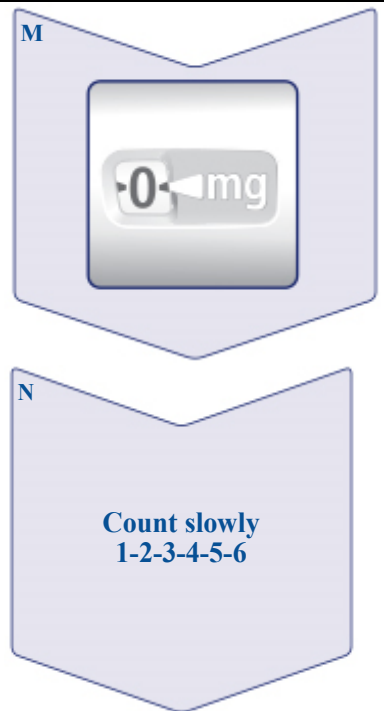

Remove the needle from your skin. If the needle is removed earlier, a stream of solution may come from the needle tip and the full dose will not be delivered.

If blood appears at the injection site, press lightly on the area to stop the bleeding.

You may see a drop of solution at the needle tip after injecting. This is normal and does not affect your dose.

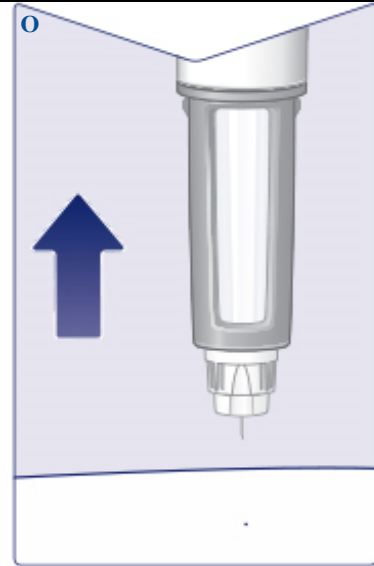

4 After your injection

Lead the needle tip into the outer needle cap on a flat surface without touching the needle or the outer needle cap.

Once the needle is covered, carefully push the outer needle cap completely on.

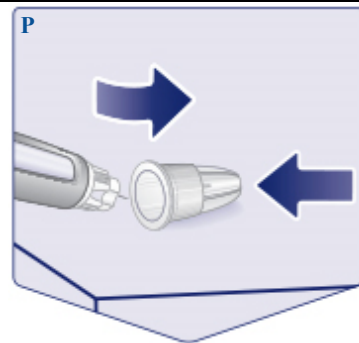

Unscrew the needle and dispose of it carefully as instructed by your doctor, nurse, pharmacist or local authorities.

Never try to put the inner needle cap back on the needle. You may stick yourself with the needle.

Always dispose of the needle immediately after each injection to prevent blocked needles, contamination, infection and inaccurate dosing. **Never store your pen with the needle attached.**

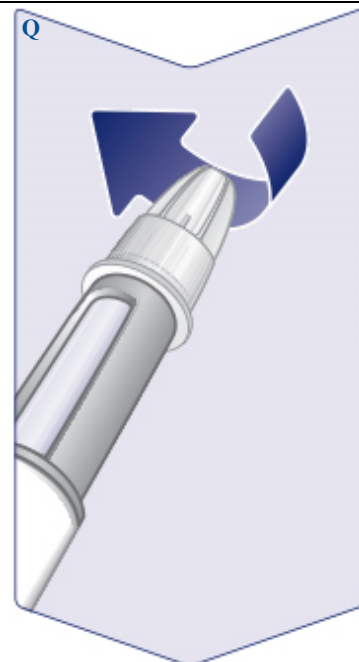

Put the pen cap on your pen after each use to protect the solution from light.

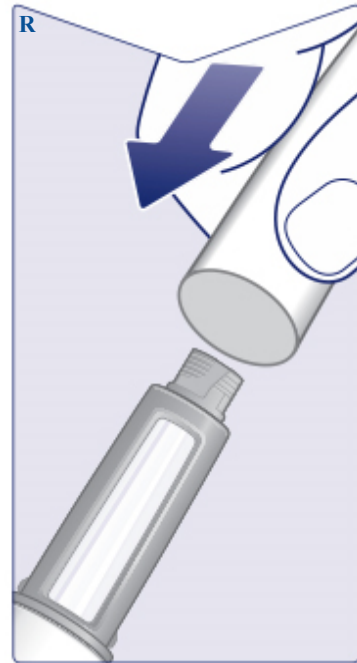

When the pen is empty, dispose of it **without** a needle on as instructed by your doctor, nurse, pharmacist or local authorities.

The pen cap and the empty carton can be disposed of in your household waste.

About your needles

How to identify a blocked or damaged needle

- If **0** does not appear in the dose counter after continuously pressing the dose button, you may have used a blocked or damaged needle.
- In this case, you have **not** received any medicine – even though the dose counter has moved from the original dose that you have set.

How to handle a blocked needle

- Change the needle as instructed in ‘**1 Prepare your pen with a new needle**’ and go to ‘**2 Set your dose**’.

Caring for your pen

Treat your pen with care. Rough handling or misuse may cause inaccurate dosing. If this happens, you might not get the intended effect of Wegovy®.

- See the back of this leaflet to read the storage conditions for your pen.
- **Do not leave the pen in a car** or another place where it can get too hot or too cold.
- **Do not inject Wegovy® that has been exposed to direct sunlight.**
- **Do not subject Wegovy® to frost and never inject Wegovy® that has been frozen.** Dispose of the pen.
- **Do not drop your pen** or knock it against hard surfaces.
- **Do not try to refill your pen.** Once empty, it must be disposed of.
- **Do not try to repair your pen** or pull it apart.
- **Do not expose your pen to dust, dirt or liquid.**

- **Do not wash, soak or lubricate your pen.** If necessary, clean it with a mild detergent on a moistened cloth.

Do you have enough Wegovy®?

If the dose counter stops before you reach your prescribed dose, there is not enough medicine left for a full dose. Dispose of the pen and use a new Wegovy® pen.



Instructions for Use

Wegovy® single-use pre-filled pen

semaglutide injection

Wegovy® comes in five strengths:

0.25 mg / 0.5 mL

0.5 mg / 0.5 mL

1 mg / 0.5 mL

1.7 mg / 0.75 mL

2.4 mg / 0.75 mL

Use Wegovy® 1 time each week



Before you use your Wegovy® pen for the first time, talk to your healthcare provider or your caregiver about how to prepare and inject Wegovy® correctly.



Pull out to get started



Important information

Read this Instructions for Use before you start using Wegovy®. This information does not replace talking to your healthcare provider about your medical condition or treatment.

- **Your Wegovy® pen is for 1 time use only.** The Wegovy® pen is for subcutaneous (under the skin) use only.
- **The dose of Wegovy® is already set on your pen.**
- **The needle is covered by the needle cover and the needle will not be seen.**
- Do not remove the pen cap until you are ready to inject.
- Do not touch or push on the needle cover. You could get a needle stick injury.
- Your Wegovy® injection will start when the needle cover is pressed firmly against your skin.
- When injecting the dose, a yellow bar will appear in the pen window.
- **Do not** remove the pen from your skin before the yellow bar in the pen window has stopped moving. If the pen is removed too early or if you have not pressed the pen firmly against the skin for the entire injection, medication may appear on the skin or squirt from the needle and you may not get your full dose of Wegovy®.
- If the yellow bar does not start moving or stops during the injection, contact your healthcare provider.
- The needle cover will lock when the pen is removed from your skin. **You cannot stop the injection and restart it later.**
- People who are blind or have vision problems should not use Wegovy® without help from a person trained to use the Wegovy® pen.

Wegovy[®] pen parts



How to use your Wegovy[®] pen

Do not use your Wegovy[®] pen without receiving training from your healthcare provider. Make sure that you or your caregiver know how to give an injection with the pen before you start your treatment.

Read and follow the instructions so that you use your Wegovy[®] pen correctly:

Preparation

Step 1. Prepare for your injection.

- **Supplies you will need to give your Wegovy[®] injection:** your Wegovy[®] pen, 1 gauze pad or cotton ball, 1 sharps disposable container for used Wegovy[®] pens.
- **Wash your hands.**
- **Check your Wegovy[®] pen.**

 Do not use your Wegovy[®] pen if:

- The pen appears to have been used or any part of the pen appears broken, for example if it has been dropped.
- The Wegovy[®] medicine looks cloudy through the pen window.
- The expiration date (Expiry) has passed.

Step 2 Choose your injection site.

- Choose your upper arms, upper legs (front of the thighs) or lower stomach (keep 2 inches away from your belly button).
- Do not inject into an area where the skin is tender, bruised, red, or hard. Avoid injecting into areas with scars or stretch marks.
- You may inject in the same body area each week, but make sure it is not in the same spot each time.

Clean the injection site. Do not touch the injection site after cleaning.

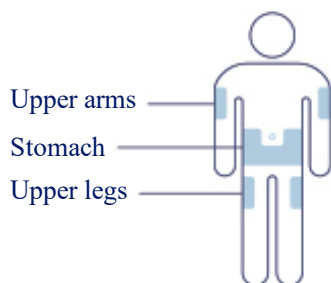

Injection

Step 3. Remove pen cap.

- Pull the pen cap straight off your pen.

Step 4. Inject Wegovy[®].

Push the pen firmly against your skin and keep applying pressure until the yellow bar has stopped moving.

- If the yellow bar does not start moving, press the pen more firmly against your skin.

What if blood appears after injection?

If blood appears at the injection site, press lightly with a gauze pad or cotton ball.



Injection

Step 3. Remove pen cap.

- Pull the pen cap straight off your pen.

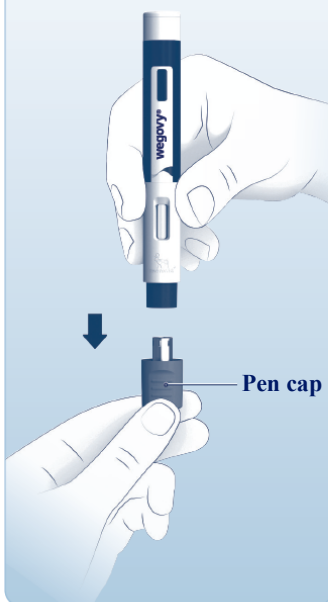

Step 4. Inject Wegovy®.

Push the pen firmly against your skin until the yellow bar has stopped moving.

- If the yellow bar does not start moving, press the pen more firmly against your skin.

What if blood appears after injection?
If blood appears at the injection site, press lightly with a gauze pad or cotton ball.



Click 1
The injection starts.

Click 2
Keep applying pressure until the yellow bar has stopped moving.

Yellow bar has stopped moving. The injection is complete.
Lift the pen slowly.

Disposal

Step 5. Dispose of pen.

Safely dispose of the pen right away after use. See “How do I throw away (dispose of) Wegovy® pens?”

i Troubleshoot

- If you experience difficulties injecting, change to a more firm injection site, such as upper leg, or upper arm or consider standing up while injecting into the lower stomach.
- If medication appears on the skin or squirts from the needle, make sure the next time you inject to keep applying pressure until the yellow bar has stopped moving. Then you can lift the pen slowly from your skin.

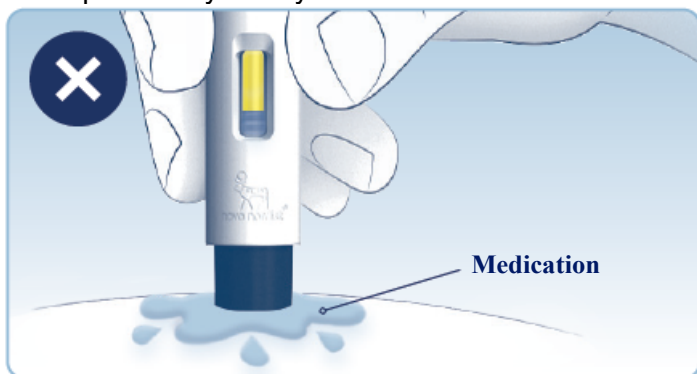

🗑️ How do I dispose of Wegovy® pens?

- Put the Wegovy® pen in a closeable, puncture-resistant sharps disposal container.
- Do not dispose of the pen in your household trash.

- Do not reuse the pen.
- Do not recycle the pen or sharps disposal container, or throw them into household trash.
- Ask your healthcare provider about options available in your area to dispose of the sharps container properly.
- The directions regarding pen handling and disposal are not intended to replace local, healthcare provider or institutional policies.
- Important: Keep your Wegovy[®] pen, sharps disposal container and all medicines out of the reach of children.

 **How do I care for my pen?**

Protect your pen

- Do not drop your pen or knock it against hard surfaces.
- Do not expose your pen to any liquids.
- If you think that your pen may be damaged, do not try to fix it. Use a new one.
- Keep the pen cap on until you are ready to inject. Your pen will no longer be sterile if you store an unused pen without the cap, if you pull the pen cap off and put it on again, or if the pen cap is missing. This could lead to an infection.

How do I store Wegovy[®]?

- Store the Wegovy[®] pen in the refrigerator between 2°C to 8°C.
- Keep Wegovy[®] in the original carton to protect it from light.
- If needed, Wegovy[®] may be stored at a temperature below 30°C in the original carton for up to 28 days.
- **Do not freeze.**
- Dispose of the pen if Wegovy[®] has been frozen, has been exposed to light or temperatures above 30°C, or has been out of the refrigerator for 28 days or longer.